



OxiMAX[®] N-65

Handheld Pulse Oximeter
Operator's Manual



Nellcor Puritan Bennett Incorporated is an affiliate of Tyco Healthcare. *Nellcor, Oxiband, Durasensor, OxiCliq, Dura-Y, MAX-FAST, and OxiMAX* are trademarks of Nellcor Puritan Bennett Incorporated or an affiliate.

Cet appareil ISM est conforme à la norme NMB-001 Canada.

To obtain information about a warranty, if any, contact Nellcor's Technical Services Department, or your local representative.

Purchase of this instrument confers no express or implied license under any Nellcor Puritan Bennett patent to use the instrument with any sensor that is not manufactured or licensed by Nellcor Puritan Bennett.

Covered by one or more of the following U.S. Patents and foreign equivalents: 4,802,486; 4,869,254; 4,928,692; 4,934,372; 4,960,126; 5,078,136; 5,485,847; 5,743,263; 5,865,736; 6,035,223; 6,298,252; 6,463,310; 6,591,123; 6,675,031; 6,708,049; 6,801,797; and Re.35,122.

Contents

Safety Information	1
Warnings	1
Cautions	4
Notes	5
Introduction	7
Intended Use for the OXIMAX N-65	7
How to Use this Manual	7
Symbols, Controls, Displays, and Indicators	9
Front Panel Description	9
Front Panel Symbols	13
Rear Panel Symbols	14
Label Symbols	15
Controls	16
Displays and Indicators	19
Audible Indicators	24
Set up the OXIMAX N-65	25
List of Components	27
Connect OXIMAX Sensor to the Monitor	27
Inaccurate Monitor Measurements	28
Battery Operation	31
Battery Power	31
Low Battery Indicator	31
Critical Battery Indication	32
Battery Installation	33
OXIMAX N-65 Operation	35
Introduction	35
Turn On the OXIMAX N-65	36
Discussion	36
Procedure	37
OXIMAX Sensor Attached	41
No OXIMAX Sensor Attached	42

Backlight On/Off	43
Adjust Pulse Beep Volume	43
Discussion	43
Procedure — During Monitoring	44
Procedure — Using Menu Structure	45
Adjust Alarm Volume	46
Discussion	46
Procedure	46
Set Time and Date	48
Discussion	48
Procedure	49
Set Alarm Silence Duration	53
Discussion	53
Procedure	53
Disable Audible Alarms	54
Discussion	54
Procedure	55
Set Alarm Limits	56
Discussion	56
Procedure	57
Alarm Limit Changed Indicator	61
Record Snap-Shot Data	61
Discussion	61
Procedure	62
Print Data	63
Discussion	63
Print Mode	65
After Printing Data	65
Procedure	67
OXIMAX Sensor Event Record	69
Event Records	69
OXIMAX Sensors and Accessories	71
Select an OXIMAX Sensor	71
OXIMAX Sensor Features	76
Biocompatibility Test	77
Optional Accessories	77
Rubber Boot With Clip	78
Functional Thermoformed Holster	79
Carrying Case	80
Water-Resistant Jacket	81

Infrared Printer	82
Thermal Paper	83
DEC-4 Extension Cable	84
Transport Boot	85
Performance Considerations	87
Performance Verification	87
OXIMAX N-65 Performance Considerations	87
Dysfunctional Hemoglobins	88
Anemia	88
Saturation	88
Pulse Rates	88
OXIMAX Sensor Performance Considerations	89
Troubleshooting	93
Error Codes	93
Corrective Action	95
EMI (Electromagnetic Interference)	99
Technical Assistance	100
Maintenance	103
Return the OXIMAX N-65	103
Service	104
Periodic Safety Checks	104
Cleaning	105
Menu Structure	107
Set Menus Quick Reference	107
Set Menu Parameters	108
Set Time/Date Parameters	110
Principles of Operation	113
Oximetry Overview	113
Automatic Calibration	114
Functional versus Fractional Saturation	115
Measured versus Calculated Saturation	115
OXIMAX Technology	116
Functional Testers and Patient Simulators	117
Specifications	119
Performance	119

Electrical	126
Environmental Conditions	128
Physical Characteristics	129
Compliance	129
Manufacturer's Declaration	130
Index	137

Safety Information

Warnings



Warnings are identified by the WARNING symbol shown above.

Warnings alert the user to potential serious outcomes, such as death, injury, or adverse events to the patient or user.



WARNING: The *OxiMAX* sensor uses the date and time provided by the *OxiMAX* N-65 handheld pulse oximeter when the sensor event record is recorded by the sensor. The accuracy of the date/time is dependent on the date/time already set in and provided by the *OxiMAX* N-65.



WARNING: Explosion hazard. Do not use the *OxiMAX* N-65 in the presence of flammable anesthetics mixture with air, oxygen, or nitrous oxide.



WARNING: Chemicals from a broken LCD display panel are toxic when ingested. Use caution when the *OxiMAX* N-65 has a broken display panel.



WARNING: Routinely monitor the patient to make sure the *OxIMAX* N-65 is functioning and the sensor is correctly placed.



WARNING: Pulse oximetry measurements and pulse signals can be affected by certain environmental conditions, *OxIMAX* sensor application errors, and certain patient conditions. See the appropriate sections of this manual for specific safety information.



WARNING: The use of accessories, sensors, and cables other than those specified may result in increased emission and/or create invalid readings of the *OxIMAX* N-65.



WARNING: Failure to cover the *OxIMAX* sensor site with opaque material in high ambient light conditions may result in inaccurate measurements.



WARNING: Do not silence the audible alarm function, or decrease the audible alarm volume, if patient safety could be compromised.



WARNING: The *OxIMAX* N-65 is a prescription device to be operated only by trained personnel. The monitor is for attended monitoring only.



WARNING: Dispose of batteries in accordance with local ordinances and regulations.



WARNING: The *OxiMAX* N-65 is not defibrillator-proof. However, it may remain attached to the patient throughout defibrillation or while an electrosurgical unit is in use. The measurements may be inaccurate throughout the defibrillation, or use of an electrosurgical unit, and shortly thereafter. To avoid shock, the caregiver should not hold the *OxiMAX* N-65 while using a defibrillator on a patient.



WARNING: Disconnect the *OxiMAX* N-65 and Nellcor *OxiMAX* sensor from the patient throughout magnetic resonance imaging (MRI) scanning. Induced current could potentially cause burns.



WARNING: To ensure accurate performance and prevent device failure, do not subject the *OxiMAX* N-65 to extreme moisture, such as direct exposure to rain. Such exposure may cause inaccurate performance or device failure.



WARNING: Do not use an *OxiMAX* N-65, *OxiMAX* sensor, or cables that appear damaged.



WARNING: Do not lift the *OxiMAX* N-65 by the sensor or extension cable because the cable could disconnect from the monitor and the monitor may drop on the patient.

Cautions



Cautions are identified by the CAUTION symbol shown above.

Cautions alert the user to exercise care necessary for the safe and effective use of the *OxiMAX* N-65 handheld pulse oximeter.



Caution: All combinations of equipment must be in compliance with IEC Standard 60601-1-1 systems requirements.



Caution: Federal law (U.S.A.) restricts this device to sale by or on the order of a physician.

Notes



Notes are identified by the **Note** symbol shown above.

Notes contain important information that may otherwise be overlooked or missed.

Introduction



WARNING: Do not make any clinical judgments based solely on the *OxIMAX* N-65. The monitor is intended only as an adjunct in patient assessment. It must be used in conjunction with clinical signs and symptoms.

Intended Use for the *OxIMAX* N-65

The *OxIMAX*TM N-65 handheld pulse oximeter is indicated for continuous or spot check monitoring of functional arterial oxygen saturation (SpO₂) and pulse rate of adult, pediatric and neonatal patients in hospital, hospital type facilities, transport and mobile environments as well as in the home care environment.

How to Use this Manual

All users should read this manual thoroughly. More experienced users of the monitor can refer directly to the topics for the information they require.

The current copy of this manual is available on the internet at:

http://www.mallinckrodt.com/respiratory/resp/Serv_Supp/ProductManuals.html

Symbols, Controls, Displays, and Indicators

Front Panel Description

This section identifies the symbols, controls, displays, and indicators on the *OxiMAX* N-65.

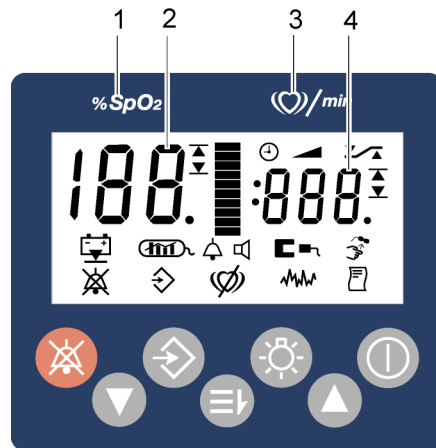

- 1 — %SpO₂ area of display

- 2 — Measured %SpO₂

- 3 — Pulse beats per minute (BPM) area of display

- 4 — Measured BPM

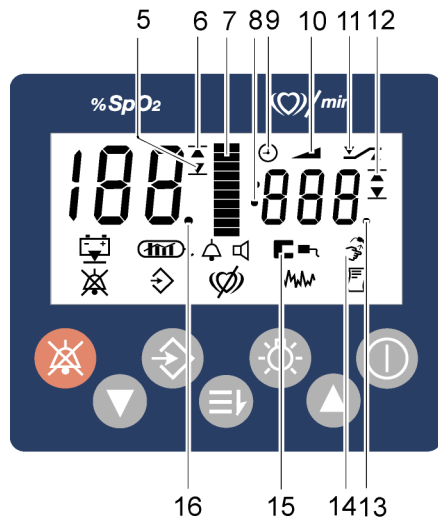

5 — %SpO2 Lower Alarm Limit indicator

6 — %SpO2 Upper Alarm Limit indicator

7 — Pulse Amplitude indicator (Blip bar)

8 — Time Colon time/date field separator

9 — Adjust Time mode indicator

10 — Adjust Volume mode indicator

11 — Set Limit mode indicator

12 — BPM Upper Alarm Limit indicator

13 — BPM Limit Changed indicator

14 — Sensor Off Patient indicator

15 — Sensor Disconnected indicator

16 — %SpO2 Limit Changed indicator

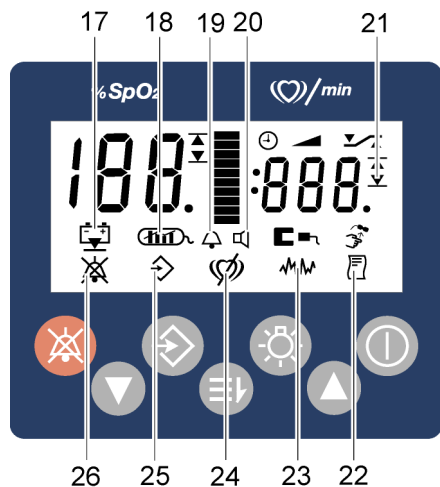

- 17 — **Low Battery** indicator

- 18 — **Data In-Sensor** indicator

- 19 — **Alarm Volume Adjust** indicator

- 20 — **Pulse Beep Tone Volume Adjust** indicator

- 21 — **BPM Lower Alarm Limit** indicator

- 22 — **Print** indicator

- 23 — **Interference** indicator

- 24 — **Pulse Search** indicator

- 25 — **Data** indicator

- 26 — **Alarm Silenced** indicator

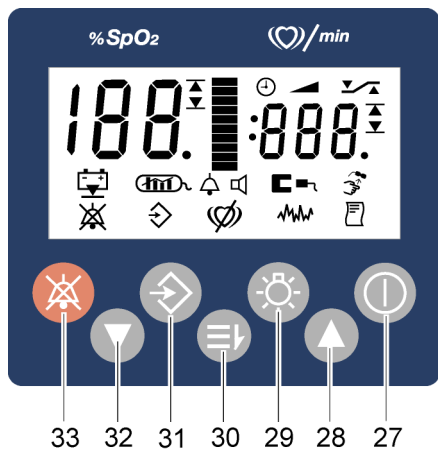

27 — **Power** button

28 — **Up Arrow** button

29 — **Backlight** button

30 — **Menu** button

31 — **Data** (Record/Print) button

32 — **Down Arrow** button

33 — **Alarm Silence** button

Front Panel Symbols

The following two symbols are located on the front panel of the monitor.

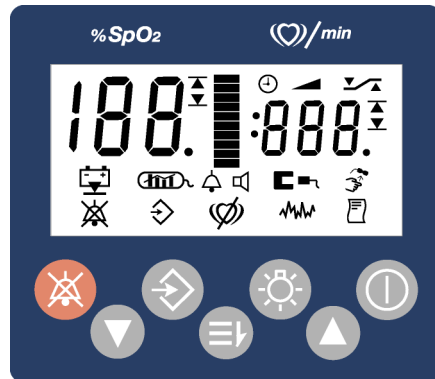

%SpO₂ Displays the measured percent of oxygen saturation.

♥/min Displays the measured pulse beats per minute.

Rear Panel Symbols

The following symbols are located on the rear panel of the monitor.

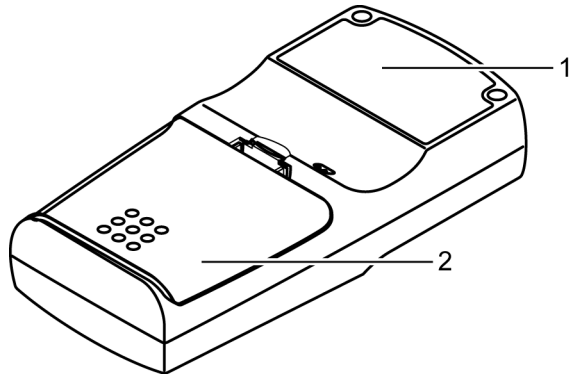

1 — Label

2 — Battery Cover



See Instructions for Use



Type BF Applied Part - Not defibrillator proof

IPX1

Resistant to liquid ingress

Rx ONLY

Rx Prescription only



Date of Manufacture

CE
0123

European union approval



Canadian/USA certification mark (electrical safety)



Russian regulatory approval



Serial number

Label Symbols

These symbols display on the monitor's labels.



Keep away from heat



Temperature limitation



Protect from moisture



Fragile



Keep upright



Humidity limitation

Controls

This section describes the controls on the front panel of the monitor. The controls are activated by pressing the button that corresponds to that control. For example, press the **Alarm Silence** button to control the audible alarm.

When the monitor is turned on, if you press a button, except the **Power** button, it results in either a valid or invalid key tone. See *Audible Indicators* on page 24. If a tone fails to emit when you press a button, contact qualified service personnel.

The following monitor display shows the buttons described in this section.

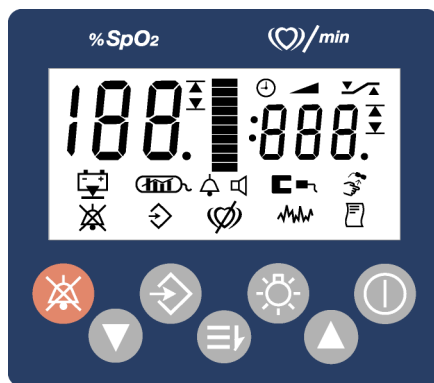

The **Alarm Silence** button. Silences the audible alarms. If you press the button when no audible alarm is active, alarms during the selected alarm silence duration are silenced. In all cases, the alarm silence times out after the selected alarm silence duration and auditory alarm capability reactivates.

Alarms that occur throughout the Power-On-Self-Test (POST) cannot be silenced.

Press and hold the **Alarm Silence** button for three seconds to display the Alarm Silence Duration menu, which allows you to adjust the alarm silence interval from 30, 60, 90, or 120 seconds, or to OFF (alarms disabled). See *Set Alarm Silence Duration* on page 53.



The **Down Arrow** button. Sequentially decreases the parameter under adjustment by one decrement. If you press and hold the button for more than three seconds it may cause the decrement to repeat.

Press the **Down Arrow** button during normal operation to decrease the pulse beep volume.



The **Data** (Record/Print) button. Stores the currently shown SpO₂ and BPM values (snap-shot data.) You can print the stored snap-shot data, such as a single-event report, snap-shot, and/or sensor-event data by pressing the **Data** button in print mode.



The **Menu** button. Press repeatedly during normal operation to display the parameters. Parameters you can set include:

- high and low SpO₂ limits
- high and low BPM limits
- alarm volume
- pulse beep volume
- data print

If you do not press any buttons for approximately 30 seconds, the monitor returns to normal operation and incorporates the selected parameter value.

See *Menu Structure* on page 107 for additional information about setting parameters.

Alarms and alarm icons are enabled when parameters are set and display in the event of an alarm condition.

Examples of alarms and alarm icons are:

- Sensor Disconnected
- Pulse Search
- Interference
- Low Battery
- **Alarm Silenced** indicator

If you press the **Menu** button while Power-On-Self-Test (POST) is activated, the Time/Date set displays.

Repeatedly pressing the **Menu** button displays the following time/date parameters you can set:

- Hour
- Minute
- Day
- Month
- Year

After the time/date parameters are set, you can return to the POST display.



The **Backlight** button. Press to toggle the backlight ON or OFF. The backlight remains on for approximately 10 minutes.



The **Up Arrow** button. While in menu mode, press repeatedly to increase a parameter by one increment. Press and hold the button for more than three seconds to repeat the increment.

Press the **Up Arrow** button during normal operation while monitoring to increase the pulse beep volume.



Note: Normal operation means:

- the monitor is turned on
- a sensor is connected to the monitor
- the sensor is applied to the patient
- the patient's %SpO₂ (oxygen saturation percentage) and pulse rate readings (BM) are being reported
- no error conditions exist



The **Power** button. Press to toggle the monitor power ON or OFF. The **Power** button has a raised protrusion (bump) at its center and a gloss surface finish for tactile differentiation from other buttons.

Displays and Indicators

The monitor display as shown below includes:

- a **Pulse Amplitude** blip bar
- functional icons
- current measured %SpO₂
- pulse rate

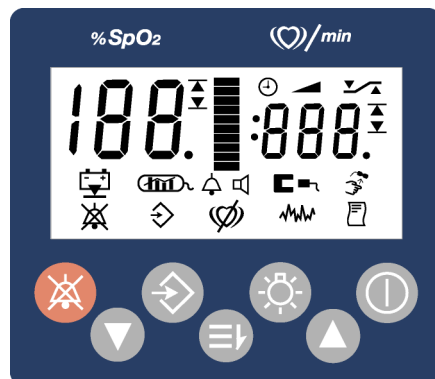

Decimal points after the %SpO₂ or pulse rate indicate that the respective limits have been changed from the power-on default values.

There are various matrices within the signal processing algorithm. Some of these are used to assess the severity of conditions presented to the monitor in SpO₂ and pulse rate measurements on a patient. Individual matrices, or combinations of them, are used to drive the icon indicators on the monitor front panel.

The signal processing algorithm increases the amount of data required for measurements of SpO₂ and pulse rate dependent on the measurement conditions. Throughout normal measurement conditions, the averaging time is six to seven seconds.

The signal processing algorithm extends the amount of data required beyond seven seconds for measurement conditions in which incoming signal quality is degraded, such as:

- low perfusion
- active patients
- ambient light
- electromagnetic interference (EMI)

If the resulting dynamic averaging time exceeds 20 seconds, the **Pulse Search** indicator appears and SpO₂ and Pulse Rate displays continue updating every second. As these conditions extend, the amount of data required continues to increase.

If the dynamic averaging time reaches 40 seconds, the **Pulse Search** indicator flashes and the SpO₂ and pulse rate displays flashing zeros to indicate a loss-of-pulse condition.

Selected display elements, such as, icons or numerals, may flash. There are three flash rates. See Table 1.

Table 1: Flash Rates

Priority	Hertz	Duty Cycle
High	1.4 Hz to 2.8 Hz	20% to 60%
Medium	0.4 Hz to 0.8 Hz	20% to 60%
Low	N/A	Constant on

%SpO₂



%SpO₂ display:

- shows the oxygen saturation level of functional hemoglobin
- shows two dashes throughout Sensor Disconnected and Sensor Off Patient conditions
- flashes the SpO₂ value when the SpO₂ is outside the alarm limits
- shows a decimal point (.) after the SpO₂ value (98.0), if alarm limits have changed from their power-on defaults



Pulse Amplitude indicator (blip bar). Indicates the dynamic pulse amplitude and rate. As the detected pulse becomes stronger, more bars light with each pulse. The reverse is true for weak pulses.

When setting alarm volume, the **Pulse Amplitude** blip bar reflects the alarm volume setting.



Pulse Rate display:



- shows the pulse rate in beats per minute
- flashes throughout loss-of-pulse alarms and when the pulse rate is outside of the alarm limits
- shows two dashes throughout Sensor Disconnected and Sensor Off Patient conditions
- shows pulse rates outside of the pulse rate range (0, 20 to 300 bpm) as the closest value within the range
- shows a decimal point (.) after the BPM value (123.), if alarm limits have changed from their power-on defaults

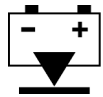

Low Battery indicator. Flashes when 15 or fewer minutes of battery capacity remain. The indicator displays constantly when the battery capacity reaches critical condition at which time the monitor indicates an error condition and shuts down.

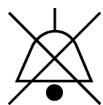

Alarm Silenced indicator. Displays when audible alarms have been silenced. It flashes when the audible alarms are disabled.



Interference indicator. Lights when the N-65 algorithm detects the incoming signal quality is degraded. Degradations can be caused by ambient light, electrical noise, electrosurgical interference, patient activity, or other causes. An intermittently lit **Interference** indicator is common during patient monitoring, and indicates that the N-65 algorithm is dynamically adjusting the amount of data required for measuring SpO₂ and Pulse Rate. When lit continuously, it indicates the N-65 algorithm has extended the amount of data required for measuring SpO₂ and Pulse Rate and, consequently, fidelity in tracking rapid changes in these values may be reduced. See *Front Panel Description* on page 9.



Pulse Search indicator. Displays before initial acquisition of a pulse signal and throughout prolonged challenging monitoring conditions. The **Indicator** flashes throughout a loss-of-pulse signal.



Data In-Sensor indicator. Displays when the sensor contains patient alarm events. The indicator flashes when the sensor memory is full.



Upper Alarm Limit indicator. Indicates that the displayed value is the upper alarm limit for SpO₂ or Pulse Rate.



Lower Alarm Limit indicator. Indicates that the displayed value is the lower alarm limit for SpO₂ or Pulse Rate.

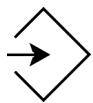

Data indicator. Displays when the monitor is in the store snap-shot data or data print mode. The indicator flashes when snap-shot data prints.



Print indicator. Displays when the monitor is in print mode. The indicator flashes when the monitor prints single-event, snap-shot, or patient alarm events data, which is stored in the sensor.



Sensor Disconnected indicator. Displays when the patient sensor is disconnected from the monitor.



Alarm Volume Adjust indicator. Displays when the monitor is in the alarm volume adjust menu.

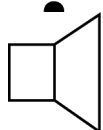

Pulse Beep Tone Volume Adjust indicator. Displays when the monitor is in the pulse beep tone volume adjust menu.



Adjust Time indicator. Displays when the monitor is in the time/date set menu.



Set Limit mode indicator. Displays when the monitor alarm limit values, or pulse rate values, are being adjusted.



Adjust Volume mode indicator. Displays when the monitor alarm volume levels are being adjusted.



Sensor Off Patient indicator. Displays when the monitor detects the sensor has come off the patient.

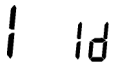

SNAP-SHOT DATA ID indicator. An alphanumeric display that shows the number of the current captured patient (SpO₂) and pulse rate (PR) values. It assigns an ID to the data captured. The ID number is shown in the %SpO₂ area of the display.

Audible Indicators

The monitor generates auditory signals for use as alarms, status indicators, and feedback. See *Audible Indicators* on page 121.

Set up the *OxIMAX* N-65



WARNING: To ensure patient safety, do not place the *OxIMAX* N-65 in any position that might cause it to fall on the patient.



WARNING: As with all medical equipment, carefully route patient cables to reduce the possibility of patient entanglement or strangulation.



WARNING: Ensure that the speaker is clear of any obstruction and that the speaker holes are not covered. Failure to do so could result in an inaudible alarm tone.



WARNING: Disconnect the *OxIMAX* N-65 and Nellcor *OxIMAX* sensor from the patient throughout magnetic resonance imaging (MRI) scanning. Induced current could potentially cause burns.



WARNING: To ensure accurate performance and prevent device failure, do not subject the *OxIMAX* N-65 to extreme moisture, such as direct exposure to rain. Such exposure may cause inaccurate performance or device failure.



WARNING: Do not use an *OxIMAX* N-65, *OxIMAX* sensor, or cables that appear damaged.



WARNING: Do not lift the *OxIMAX* N-65 by the sensor or extension cable because the cable could disconnect from the monitor and the monitor may drop on the patient.



WARNING: Use only the Nellcor extension cable DEC-4 with the *OxIMAX* N-65. Do not attach any cable that is intended for computer use to the *OxIMAX* sensor port. Do not connect any device other than a Nellcor-approved *OxIMAX* sensor to the *OxIMAX* sensor connector. Do not use the DEC-8 with the monitor.

List of Components

Quantity	Item
1	<i>OXIMAX</i> N-65 handheld pulse oximeter
4	Alkaline “AA” size, 1.5-volt batteries
1	Nellcor <i>OXIMAX</i> sensor or sensor assortment pack
1	Compact disk (<i>OXIMAX</i> N-65 manuals) and/or operator’s manual (applicable to country of sale)
1	Quick guide adhesive label

Connect *OXIMAX* Sensor to the Monitor



WARNING: Pulse oximetry readings and pulse signals can be affected by certain ambient environmental conditions, *OXIMAX* sensor application errors, and certain patient conditions. See the appropriate sections of the manual for specific safety information:

- *Safety Information* on page 1.
- *OXIMAX Sensor Performance Considerations* on page 89.
- *OXIMAX Sensors and Accessories* on page 71.



Caution: Use only Nellcor-approved *OXIMAX* sensors and, if needed, the DEC-4 extension cable.

Connect a Nellcor *OxiMAX* SpO₂ sensor to the monitor SpO₂ sensor port. You may use an extension cable to provide more distance between the monitor and the sensor. Use only the DEC-4 extension cable available from Nellcor.

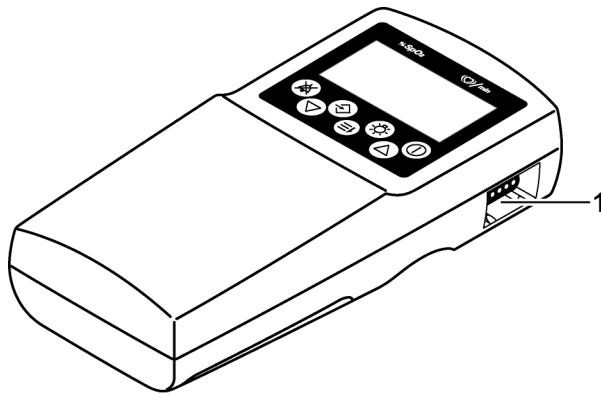

1 — SpO₂ *OxiMAX* Sensor Port

Inaccurate Monitor Measurements

Physiological conditions, medical procedures, or external agents that may interfere with the monitor's ability to detect and display accurate measurements include:

- incorrect application of the *OxiMAX* sensor
- placement of the *OxiMAX* sensor on an extremity with a blood pressure cuff, arterial catheter, or intravascular line
- excessive patient activity
- intravascular dyes, such as indocyanine green or methylene blue
- externally applied coloring agents, such as nail polish, dye, or pigmented cream

- failure to cover the *OxiMAX* sensor site with opaque material in high ambient light conditions
- venous pulsation
- dysfunctional hemoglobin
- low perfusion

Loss-of-pulse signal can occur for the following reasons:

- the *OxiMAX* sensor is applied too tightly
- defibrillation
- a blood pressure cuff is inflated on the same extremity as the one with the *OxiMAX* sensor attached
- there is arterial occlusion proximal to the *OxiMAX* sensor
- poor peripheral perfusion
- loss of pulse/cardiac arrest

High ambient light sources that can interfere with the performance of an SpO₂ *OxiMAX* sensor are:

- surgical lights (especially those with a xenon light source)
- bilirubin lamps
- fluorescent lights
- infrared heating lamps
- direct sunlight

Battery Operation



WARNING: Dispose of battery in accordance with local ordinances and regulations.

Battery Power

The *OxiMAX* N-65 uses batteries to power the monitor. A new set of batteries provides between 15 to 40 hours of operation depending on the battery type.

Low Battery Indicator

The **Low Battery** indicator flashes and a low priority alarm sounds when approximately 15 minutes of operation remains available. Replace the batteries. See *Battery Installation* on page 33.

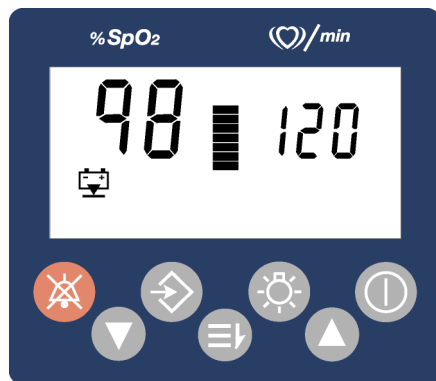



Caution: 15 minute indicator for remaining battery operating time is approximate and is based on Alkaline AA batteries. Remaining operating time may be different for other types of batteries.



Caution: Periodically check the battery for corrosion. If the *OxiMAX* N-65 is to be stored for three months or longer, remove the batteries from the monitor before storage.

Critical Battery Indication

When the batteries are critically low, the monitor:

- displays an error message (Er 521)
- sounds a high priority alarm
- shuts down

Replace the batteries and restart the monitor. See *Battery Installation* on page 33.

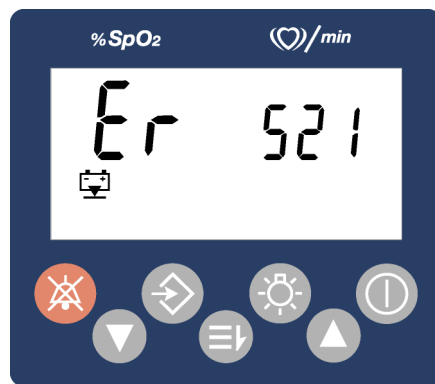

Battery Installation

To install batteries:

1. Turn off the power.
2. Pull the battery compartment latch downward toward the bottom of the monitor, and remove the battery access door.
3. Install four AA size batteries as shown in Figure 1.

4. Replace the battery access door.

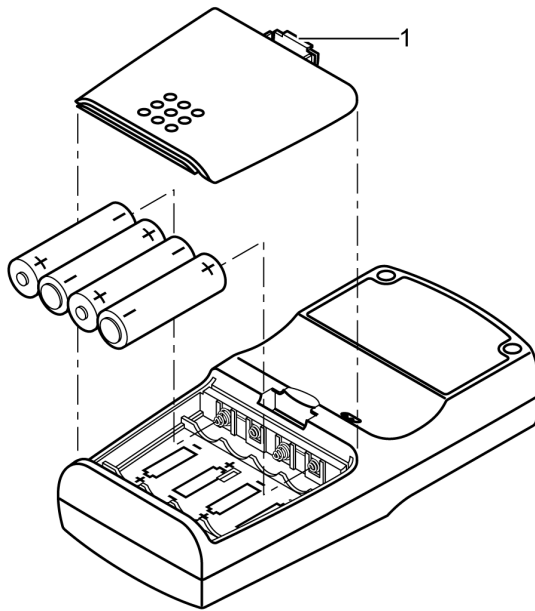

1 — Battery compartment latch

Figure 1: Battery Installation



WARNING: Explosion hazard. Do not use the *Oximax N-65* in the presence of flammable anesthetics mixed with air, oxygen, or nitrous oxide.



WARNING: Dispose of batteries in accordance with local ordinances and regulations.

OxIMAX N-65 Operation

Introduction

The parameters of the OxIMAX N-65 are set at the factory according to Table 2. The parameters may be set on an individual basis by the clinician.



Note: This section contains detailed information on setting parameters. For quick reference information, see *Set Menu Parameters* on page 108 and *Set Time/Date Parameters* on page 110.

Parameters remain in effect until the monitor is turned off.

Table 2: Parameter Ranges and Defaults

Parameter	Ranges/ Selections	Factory Defaults
%SpO ₂ Upper Alarm Limit	Lower Alarm Limit plus 1 to 100%	100%
%SpO ₂ Lower Alarm Limit	20% to Upper Alarm Limit minus 1	85%
Pulse Rate Upper Alarm Limit	Lower Alarm Limit plus 1 to 250 bpm	170 bpm
Pulse Rate Lower Alarm Limit	30 bpm to Upper Alarm Limit minus 1	40 bpm

Table 2: Parameter Ranges and Defaults (Continued)

Parameter	Ranges/ Selections	Factory Defaults
Alarm Silence Duration	Alarms 30, 60, 90, 120 seconds, OFF	30 seconds
Alarm Volume	1 to 10	10
Pulse Beep Volume	0 to 10	10

Turn On the *OXI*MAX N-65

Discussion

Verify the monitor works properly and is safe to use. Proper operation of the monitor is verified each time it is turned on as described in this procedure. The verification procedure Power-On-Self-Test (POST) takes approximately 10 seconds to complete. When the monitor is turned on, POST automatically tests the monitor circuitry and functions.



Caution: During the Power-On-Self-Test (POST) immediately after power-up, confirm that all display segments and icons are shown and the monitor speaker sounds a one-second tone.



WARNING: If you do not hear the POST pass tone, do not use the *OXI*MAX N-65.

When the monitor is turned on, the backlight remains on and the display cycles through the following sequence as POST takes place:

- All display graphics are shown for three seconds and the backlight is turned on.
- The display goes blank (all display elements off) for one second.
- The software version number shows for 3 seconds as a three digit number in the right number field and two dashes in the left number field.
- The current time of day is shown in 24 hour format.
- Successful completion of POST is announced by a POST pass tone. A failed POST is announced by a high-priority alarm tone.

Procedure

To turn on the monitor:



1. Press the **Power** button to turn on the monitor.

The backlight remains on throughout POST.

All display numbers and icons show for three seconds. The backlight is on while all numbers and icons are shown.

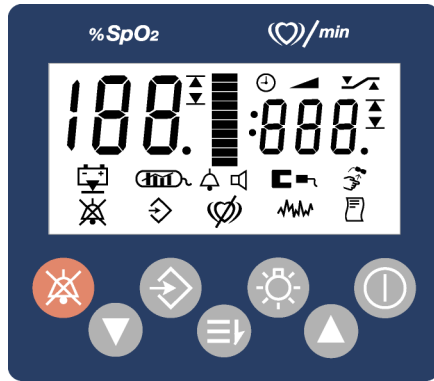

2. The display goes blank for one second.



- The software version number appears for 3 seconds as a three digit number in the right number field and two dashes in the left number field.

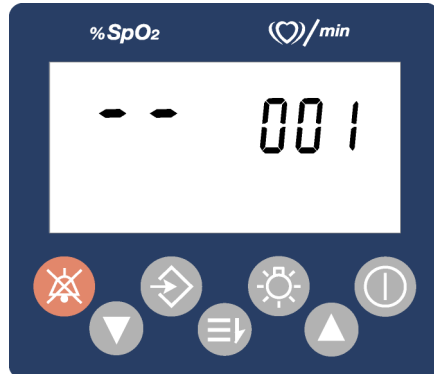

Note: The software version 001 is an example. Check the monitor for the software version installed. Write down the software version number and have it available prior to requests for technical assistance.

- The current time displays in a 24-hour format.



5. If the monitor detects a problem, an error tone sounds and an error code (Er) and the error number displays. See *Troubleshooting* on page 93.

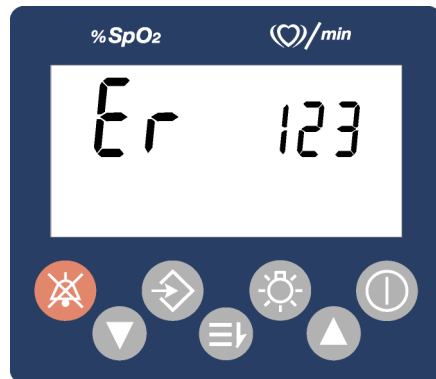

6. Upon successful completion of POST, the monitor sounds a one-second tone to indicate it has passed the test.



WARNING: Ensure the speaker is clear of any obstructions and the speaker holes are not covered. Failure to do so could result in an inaudible alarm tone.



Note: The POST pass tone also functions as an audible confirmation that the speaker performs properly.

OxIMAX Sensor Attached

 When an *OxIMAX* sensor contains patient event alarm data, and is attached to the monitor, the **Data In-Sensor** indicator is shown.

The monitor shows two dashes in the %SpO₂ and Pulse Rate displays as it searches for a valid pulse. For optimal performance allow the monitor to search and lock onto a pulse for approximately 10 seconds.

When a valid pulse is detected, the monitor begins monitoring and displays patient parameters.



Movement of the blip bar indicates that real-time data is displayed. Continue to listen for the pulse beep tone as the monitor is used. If it does not sound with each pulse, it indicates one of the following:

- pulse beep volume is off
- speaker/audio has malfunctioned
- signal is corrupted
- *OxIMAX* N-65 has stopped functioning

When an *OxiMAX* sensor is attached to the monitor and applied to a patient, and loses the pulse signal, the monitor displays [- / - -] (two dashes and two dashes) and displays the **Pulse Search** icon as shown on the monitor.

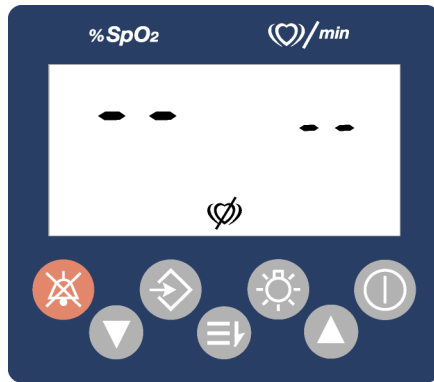

No *OxiMAX* Sensor Attached

Upon successful completion of POST, the monitor sounds a one-second tone indicating that it has passed POST.

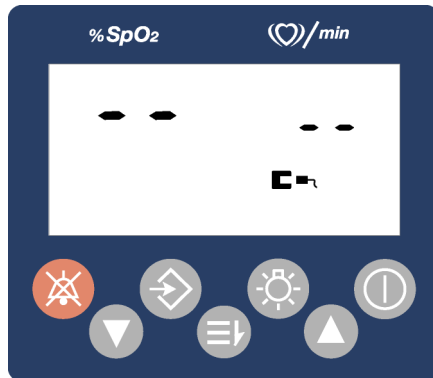

The monitor displays [- - / - -] (two dashes and two dashes) and the **Pulse Search** indicator does not display when the monitor fails to detect an *OxiMAX* sensor or an invalid sensor.

Backlight On/Off

The backlight turns off after approximately 10 seconds.



With the monitor turned on, press the **Backlight** button to turn the monitor backlight on or off.



Caution: When adjusting any menu parameter, the SpO₂ and BPM do not display, but they continue to record.

Adjust Pulse Beep Volume

Discussion

There are two ways to adjust the pulse beep volume:

- during monitoring
- using the menu structure

Procedure — During Monitoring

To change the pulse beep volume during monitoring:



Press the **Up Arrow** or **Down Arrow** button while monitoring to increase or decrease the pulse beep volume.



The Pulse Amplitude (blip bar) increments or decrements as a relative indicator of the current volume. Attempted adjustments outside the range generate an invalid key tone.

The minimum pulse rate volume is none, or OFF (no blip bar segments shows.) The maximum pulse rate volume is ten (ten segments.)

The **Beep Tone Volume Adjust** indicator flashes when the pulse beep volume is adjusted to zero.



Note: When the monitor times-out in 30 seconds, the parameter is set and the monitor display returns to the monitoring mode.

Procedure — Using Menu Structure



Note: For quick reference information on using the menu structure to set parameters, see *Set Menu Parameters* on page 108.

To adjust the pulse beep volume using the menu structure:



1. From the main monitoring screen, press the **Menu** button five times until the pulse beep volume level is shown and the monitor sounds.

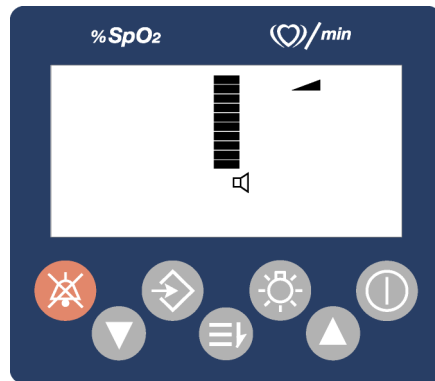

2. Press the **Up Arrow** button or the **Down Arrow** button until the desired tone level is heard.



3. Press the **Menu** button three times to set the tone volume and return to normal operation.

Adjust Alarm Volume

Discussion

When the Alarm Volume display shows, adjust the alarm volume by pressing the **Up Arrow** or **Down Arrow** button. The **Pulse Amplitude** (blip bar) increments or decrements as a relative indicator of the current alarm volume. Attempted adjustments outside the range generate an invalid key tone.



Note: When the monitor times-out in 30 seconds, the parameter is set and the monitor display returns to the normal mode.

Procedure



To adjust the alarm volume:

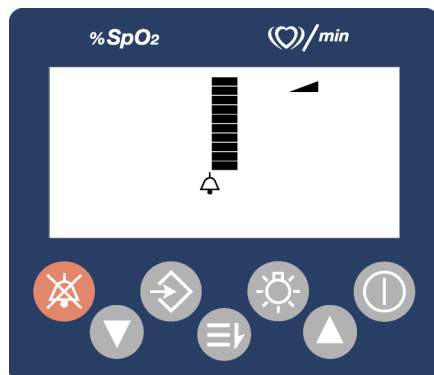

WARNING: Do not silence the audible alarm function, or decrease the audible alarm volume, if patient safety could be compromised.

1. From the main monitor screen, press the **Menu** button six times until the alarm volume screen appears.



2. Press the **Up Arrow** or **Down Arrow** button to increase or decrease alarm volume.

3. Press the **Menu** button two times to set the alarm level and return to the monitor display screen.

Set Time and Date

Discussion



WARNING: The *OxiMAX* sensor uses the date and time provided by the *OxiMAX* N-65 when the patient alarm events are recorded to the memory chip in the sensor. The accuracy of the date/time used for patient alarm events depends on the date/time already set in, and provided by the monitor.



Note: When the monitor times-out in 30 seconds, the parameter is set and the monitor display returns to the normal mode.



When you make the month entry, the monitor checks the day selection to ensure the date is valid. If the day selection is not valid for the month selected, the menu display returns to the day selection display.

When you make the year entry, the monitor checks the day and month selections to ensure the selections are valid. If the day or month selection is not valid for the year selected, the menu display returns to the day selection display.



Examples of invalid dates:

- 30 February
- 31 February
- 31 April
- 31 June
- 31 September
- 31 November



- 29 February on a non-leap year

Procedure

To set the time and date:

1. From the main monitor screen, press the **Power** button to turn the monitor off.

2. Press the **Power** button to turn the monitor on.

3. While the monitor is in the POST mode, press the **Menu** button until the set hours display shows. The hours display (13) will flash.



4. Press the **Up Arrow** button or the **Down Arrow** button until the desired hours appear.





5. Press the **Menu** button to set the hours and show the minutes set display. The minutes display (45) flashes.



6. Press the **Up Arrow** button or the **Down Arrow** button until the desired minutes appear.



7. Press the **Menu** button to set the minutes and show the day set display. The day (29) flashes.





8. Press the **Up Arrow** button or the **Down Arrow** button until the desired day is shown.



9. Press the **Menu** button to set the day and show the month set display. The month (7) flashes.



10. Press the **Up Arrow** button or the **Down Arrow** button until the desired month is shown.



11. Press the **Menu** button to set the month and display the year set display. The year (2004) will flash.



12. Press the **Up Arrow** button or the **Down Arrow** button until the desired year is shown.



13. Press the **Menu** button to set the year and return to normal operation.

Set Alarm Silence Duration

Discussion

When the Alarm Silence Duration display shows, you can adjust the alarm silence duration of the high, medium, and low-priority alarms.

A low battery low-priority alarm cannot be silenced.



Note: When the monitor times-out in 30 seconds, the parameter is set and the monitor returns to the normal mode.

Procedure

To set the alarm silence duration:





1. From the main monitor screen, press the **Alarm Silence** button until SEC or OFF appears on the pulse rate area of the display. Then, release the button.



WARNING: Do not silence the audible alarm function, or decrease the audible alarm volume, if patient safety could be compromised.

Available alarm silence durations are OFF (alarm disabled), 30, 60, 90, and 120 seconds.



-  2. Press the **Up Arrow** button or the **Down Arrow** button until the desired alarm silence duration is shown.
-  3. Press the **Alarm Silence** button to set the shown alarm silence duration and return to normal operation.

Disable Audible Alarms

Discussion

When the alarm silence duration is set to OFF the monitor produces no audible alarms. The **Alarm Silence** indicator flashes while the alarm silence duration is set to OFF.



Note: When the monitor times-out in 30 seconds, the parameter is set and the monitor display returns to the normal mode.

Procedure

To disable audible alarms:



WARNING: Do not silence the audible alarm function, or decrease the audible alarm volume, if patient safety could be compromised.



1. From the main monitor screen, press the **Alarm Silence** button until **OFF** displays in the pulse rate area of the monitor. Release the button.

Available Alarm silence durations are OFF, 30, 60, 90, and 120 seconds.

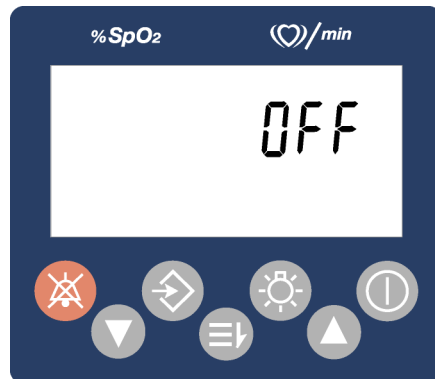



2. Press the **Alarm Silence** button to set the alarm silence duration to OFF and return to normal operation.

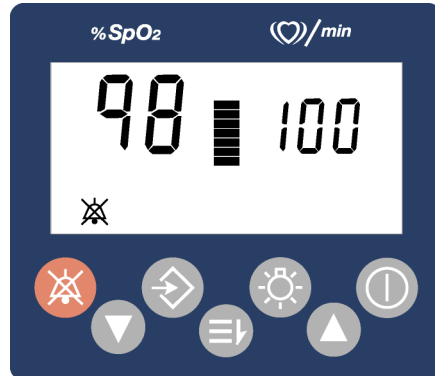

The **Alarm Silence** indicator flashes and an audible reminder sounds every three minutes while the alarm silence duration is set to OFF.

Set Alarm Limits

Discussion

The Alarm Limit display allows you to adjust the upper and lower saturation and pulse rate limits.

Press and hold the **Up Arrow** or **Down Arrow** buttons to scroll rapidly through the limit values.

The **Alarm Limit Changed** indicator displays anytime an alarm limit changes. See *Alarm Limit Changed Indicator* on page 61.



Note: When the monitor times-out in 30 seconds, the parameter is set and the monitor display returns to the normal monitoring.

Procedure

To set alarm limits:



1. From the main monitor screen, press the **Menu** button once. The SpO2 lower alarm limit displays.

The %SpO2 low alarm limit range is 20% to 99%. The upper value of the %SpO2 low alarm limit is limited to the %SpO2 upper alarm limit. The %SpO2 low alarm limit cannot be set equal to, or higher than, the %SpO2 upper alarm limit.



2. Press and hold the **Up Arrow** or **Down Arrow** buttons to scroll rapidly through the values.





3. Press the **Menu** button to set the limit value. The SpO2 upper alarm limit displays.







The %SpO₂ upper alarm limit range is 21% to 100%. The lower value of the %SpO₂ upper alarm limit is limited to the %SpO₂ low alarm limit. The %SpO₂ upper alarm limit cannot be set equal to or lower than the %SpO₂ low alarm limit.

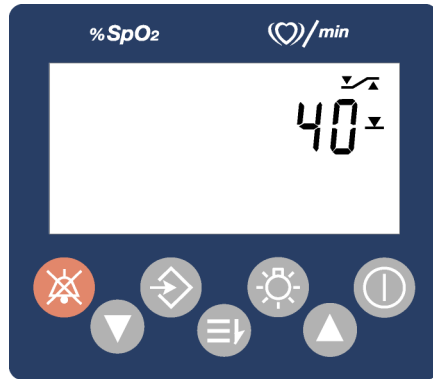

-  4. Press the **Up Arrow** or **Down Arrow** buttons to increase or decrease the upper alarm limit.
- 
-  5. Press the **Menu** button to set the limits value. The BPM lower alarm limit displays.

The pulse rate low alarm limit range is 30 to 249. The upper value of the pulse rate low alarm limit is limited one number lower than the pulse rate upper alarm limit. The pulse rate low alarm limit cannot be set equal to or higher than the pulse rate upper alarm limit.



-  6. Press the **Up Arrow** or **Down Arrow** buttons to increase or decrease the lower limit.
- 
-  7. Press the **Menu** button to set the limit value. The BPM upper alarm limit displays.

The pulse rate upper alarm limit range is 31 to 250. The lower value of the pulse rate upper alarm limit is limited to one number above the pulse rate low alarm limit. The pulse rate upper alarm limit cannot be set equal to or lower than the pulse rate low alarm limit.





8. Press the **Up Arrow** or **Down Arrow** button to increase or decrease the upper pulse rate limit.



9. Press the **Menu** button to confirm the alarm limit settings.

10. Press the **Menu** button until you return to normal operation.



Note: Limit changes are in effect only as long as the monitor remains on. When it is turned off, the default limits are restored. When the monitor is turned on, the default limits will be in effect.

Alarm Limit Changed Indicator

Alarm limits that have changed from the default values are identified by a decimal point (.) after the shown value (%SpO₂ or BPM).

The **Alarm Limit Changed** indicator displays anytime an alarm limit changes.

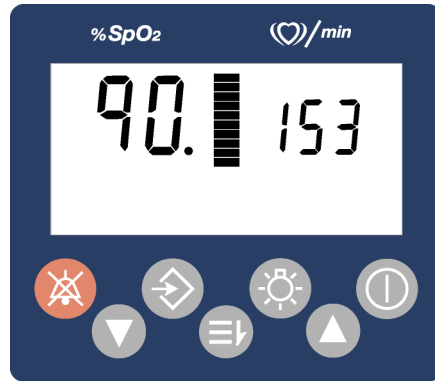

Record Snap-Shot Data

Discussion

The monitor contains an internal memory that can store 50 patient data records (snap-shots). You can print data records. Data are retained in the monitor memory while it remains on and cleared when it is turned off, or powers itself off. If the data are cleared, they are not available to print. Replacement of the monitor batteries clears patient data.

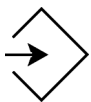

The **Data** indicator flashes at a medium priority rate when the monitor patient memory is full.

Procedure

To record data:



1. From the main monitor screen, press the **Data** button to capture a record of the patient data (snap shot). The captured data displays.

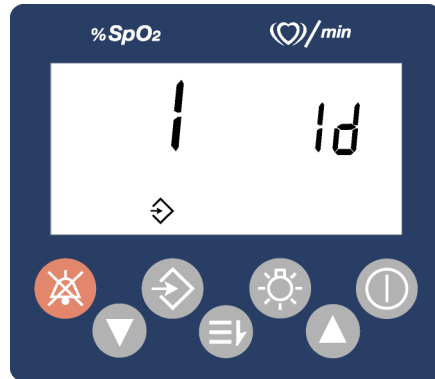

The number (1) in the SpO₂ field is the identification (ID) number of captured snap-shots.

When you press the **Data** button, and there is no empty event memory location available, the monitor:

- displays the last ID number assigned (50)
- the **Data** icon continues to flash at the medium priority rate
- an invalid key tone sounds
- the monitor returns to the normal mode after approximately three seconds

Print Data

Discussion

The monitor can print data when used with a Citizen PD-22T portable printer, which is available from Nellcor Customer Services at 1.800.635.5267, or your local Nellcor representative.



Caution: Ensure that the printer model number contains a “T,” which indicates that the printer has been configured for use with the *OXIMAX N-65*.



Note: Read the entire user’s manual for the Citizen PD-22T portable printer prior to operating the printer with the monitor.

The monitor must be linked via infrared (IR) to a compatible printer to print.



Note: The monitor remains on if there are patient alarm event data stored.

Print data contains one or more of the following:

- a summary report, if currently connected to a patient

The summary report includes the date, current time, duration of the current monitoring session, and the minimum, maximum, and mean of the SpO₂ and pulse rate.

- a snap-shot report, if any are stored

- sensor event data (patient alarm event data), if a sensor with patient event data is connected to the monitor

The monitor prints all available data as shown in Figure 2.

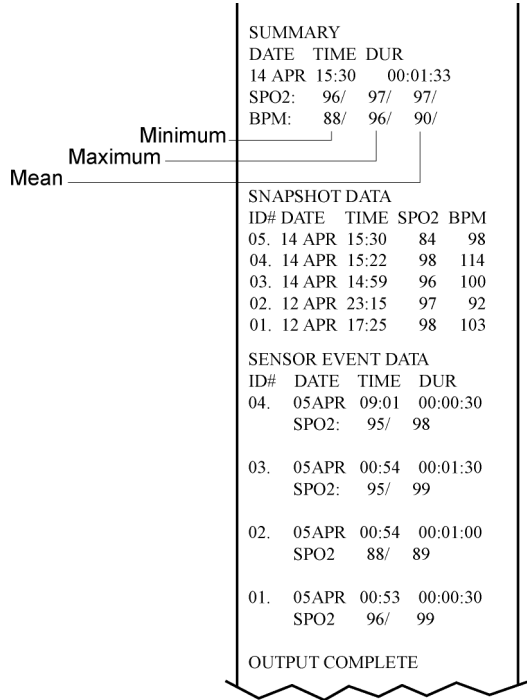

Figure 2: Combined Printed Data

Print Mode

If you press the **Data** button in the print menu when no data is stored, and the device is not connected to a patient, an invalid key tone sounds and the monitor transitions to normal mode.

The **Print-mode** indicator (page icon) flashes at the medium rate throughout print mode.

When the print function is complete, the display returns to the normal mode. If the monitor times-out before the **Data** button is pressed, the display returns to the normal mode.

The **Menu** button is disabled during print mode.

If there is no communication with the printer for 30 seconds, print mode is aborted and the display returns to normal mode.

After Printing Data

The summary report data is purged after it is printed or on time-out due to printer communication failure.

Snap-shot or sensor-event data is not purged after printing or time-out due to printer communication failure. Instead, it is purged from the monitor's memory at power off. Sensor-event data is retained in the sensor and loads/reloads to the monitor memory at power on.

Alarm annunciation and patient monitoring is disabled during active printing when the monitor is communicating with printer.

If snap-shot data are stored in the monitor memory, the **Data** icon shows on the print data display. If sensor-event data are stored in sensor memory, the **Data In-Sensor** icon shows on the print data display. If both types of data are stored, both icons show. If no data are stored, neither icon shows and the display is blank.

The monitor and sensor does not differentiate between patients. Use caution when reviewing the report as the list of snap-shots may contain data from more than one patient. Also, if a single-use sensor is used more than once, the sensor trend report section can contain data from more than one patient.



Note: The snap-shot list is deleted when the monitor is turned on. When first connecting a single-use sensor, look for the **Data In-Sensor** icon.

Procedure

To print data:

1. Align the printer and the monitor.
2. Orient the printer and monitor as shown in Figure 3. The alignment of the infrared ports of the printer and the monitor must not exceed two feet and must not be closer than six inches (15 cm).

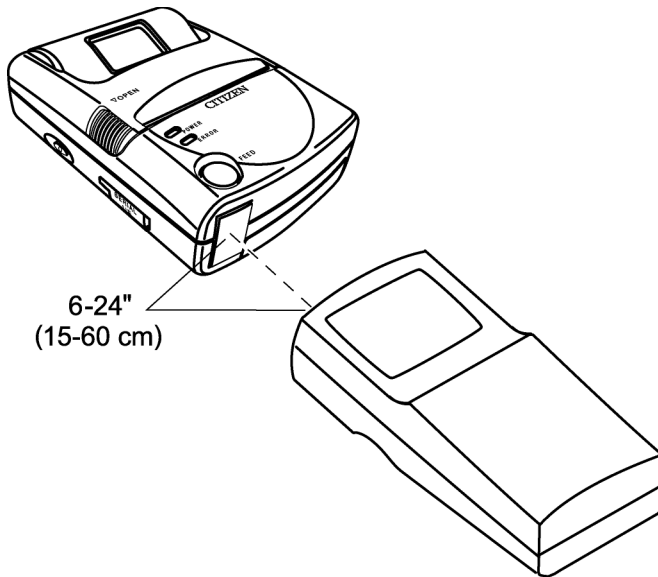
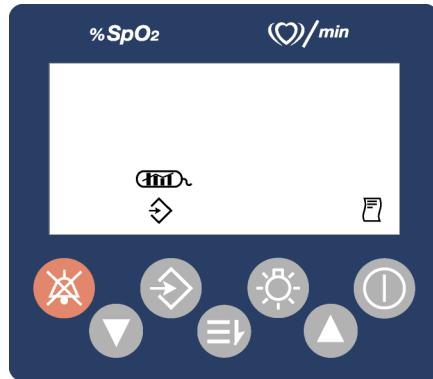

Figure 3: Printer Alignment



3. From the main monitor screen, press the **Menu** button seven times. The print display is shown.



4. Press the **Data** button to start printing. During printing, the stored snap-shot number displays for each snap-shot.

OxIMAX Sensor Event Record

Event Records



WARNING: The *OxIMAX* sensor uses the date and time provided by the *OxIMAX* N-65 when the sensor event record is recorded by the sensor. The accuracy of the date/time is dependent on the date/time already set in and provided by the monitor.

The adhesive *OxIMAX* sensors are capable of storing patient alarm events in the memory chip. The sensor-event data record allows alarm event history to travel with the patient on the sensor's memory chip for quick assessment at every point of care where *OxIMAX* monitors are used.

The patient alarm data are stored (recorded) with the monitor limit/threshold settings that were active at the time of the event on the recording monitor. These events can be viewed on the next *OxIMAX* enabled monitor to which the patient is connected when the patient moves to a new point of care.

An event occurs when the %SpO₂ value exceeds either the upper or lower alarm limit for at least 15 seconds. The monitor records patient alarm events to the memory chip in the sensor every 5 minutes. The maximum number of events that can be stored in an *OxIMAX* sensor is typically 100.

Event records can be viewed only after an *OxiMAX* sensor containing patient alarm events has been connected to an *OxiMAX* monitor capable of displaying sensor event records. The *OxiMAX* N-65 does not support viewing sensor event records, but does support printing sensor event records. Event records are designed to view patient events from prior areas of care or transport (history), while monitor trend should be used to view data or events from a patient currently being monitored.

The **Data In-Sensor** indicator displays when the sensor contains patient alarm events. The **Data In-Sensor** indicator flashes when the sensory memory is full.

Recording and viewing of *OxiMAX* sensor-event data is only available on *OxiMAX* enabled monitors. The *OxiMAX* sensors may function on older technology monitors, but the *OxiMAX* sensor event record feature is not available.

OxIMAX Sensors and Accessories

Select an OxIMAX Sensor



WARNING: The *OxIMAX* sensor uses the date and time provided by the *OxIMAX* N-65 when the sensor event record is recorded by the sensor. The accuracy of the date/time is dependent on the date/time already set in and provided by the monitor.



WARNING: Failure to cover the *OxIMAX* sensor site with opaque material in high ambient light conditions may result in inaccurate measurements.



WARNING: Before use, carefully read the applicable *OxIMAX* sensor Directions For Use, including all warnings, cautions, and instructions.



WARNING: Do not use a damaged *OxIMAX* sensor or extension cable. Do not use an *OxIMAX* sensor with exposed optical components.



WARNING: Use only Nellcor-approved *OxIMAX* sensors and extension cables with the *OxIMAX* N-65. Other sensors or extension cables may cause improper monitor performance.



WARNING: Do not attach any cable to the *OxIMAX* sensor port connector that is intended for computer use.



WARNING: Tissue damage can be caused by incorrect application or duration of use of an *OxIMAX* sensor. Inspect the *OxIMAX* sensor site periodically as directed in the *OxIMAX* sensor Directions For Use.



WARNING: Pulse oximetry readings and pulse signals can be affected by ambient environmental conditions, *OxIMAX* sensor application errors, and patient conditions.



WARNING: Do not immerse or wet the *OxIMAX* sensor as this may damage the sensor.



WARNING: Do not lift the monitor by the *OxIMAX* sensor or extension cable because the cable could disconnect from the monitor, causing the monitor to drop on the patient.



Caution: The *OxIMAX* Sensor Disconnected icon and associated alarm indicate that either the *OxIMAX* sensor is disconnected or the wiring is faulty. Check the *OxIMAX* sensor connection and, if necessary, replace the *OxIMAX* sensor, extension cable, or both.

For additional information on monitor measurements, see *Inaccurate Monitor Measurements* on page 28.

For a complete current list of all *OxIMAX* sensors applicable to the *OxIMAX* N-65 refer to the latest Sensor Accuracy Grid posted on the Internet at:

http://www.mallinckrodt.com/respiratory/resp/Serv_Supp/ProductManuals.html

When selecting an *OxIMAX* sensor consider the following:

- patient weight and activity
- adequacy of perfusion
- available *OxIMAX* sensor sites
- need for sterility
- anticipated duration of monitoring

For additional information refer to Table 3 or contact your local Nellcor Representative. Refer to *OXIMAX Sensor Performance Considerations* on page 89 for additional information on *OxiMAX* sensor performance.

Table 3: Nellcor Oximetry Sensor Models and Patient Weights

OxiMAX Sensor	Model	Patient Size > = greater than < = less than
<i>OxiMAX</i> MAX- FAST adhesive forehead sensor, single-patient use	MAX-FAST	>10 kg (22 lbs)
<i>OxiMAX</i> Softcare nonadhesive sensor, single-patient use, preterm infant	SC-PR	<1.5 kg (3.3 lbs)
<i>OxiMAX</i> Softcare nonadhesive sensor, single-patient use, neonate	SC-NEO	1.5 kg to 5 kg (3.3 to 11 lbs)
<i>OxiMAX</i> Softcare nonadhesive sensor, single-patient use, adult	SC-A	>40 kg (88 lbs)
<i>OxiMAX</i> adhesive sensor, single-patient use, adult	MAX-A	>30 kg (66 lbs)
<i>OxiMAX</i> adhesive sensor, single-patient use, adult, longer cable 36 inches (91.44 cm)	MAX-AL	>30 kg (66 lbs)
<i>OxiMAX</i> adhesive sensor, single-patient use, neonatal/adult	MAX-N	<3 kg or >40 kg (<6.6 lbs or >88 lbs)
<i>OxiMAX</i> adhesive sensor, single-patient use, pediatric	MAX-P	10 to 50 kg (22 to 110 lbs)
<i>OxiMAX</i> adhesive sensor, single-patient use, infant	MAX-I	3 to 20 kg (6.6 to 44 lbs)

Table 3: Nellcor Oximetry Sensor Models and Patient Weights (Continued)

<i>OXIMAX</i> Sensor	Model	Patient Size > = greater than < = less than
<i>OXIMAX</i> adhesive sensor, single-patient use, adult nasal	MAX-R	>50 kg (110 lbs)
<i>OXIMAX</i> OxiCliq [®] adhesive sensor, single-patient use, adult reusable cable	OxiCliq A	>30 kg (66 lbs)
<i>OXIMAX</i> OxiCliq adhesive sensor, single-patient use, neonatal/adult, reusable cable	OxiCliq N	<3 kg or >40 kg (<6.6 lbs or >88 lbs)
<i>OXIMAX</i> OxiCliq adhesive sensor, single-patient use, pediatric, reusable cable	OxiCliq P	10 to 50 kg (22 to 110 lbs)
<i>OXIMAX</i> OxiCliq adhesive sensor, single-patient use, infant, reusable cable	OxiCliq I	3 kg to 20 kg (6.6 to 44 lbs)
<i>OXIMAX</i> Durasensor [®] finger-clip sensor, reusable, adult	DS-100A	>40 kg (88 lbs)
<i>OXIMAX</i> Oxiband [®] sensor, reusable, neonatal/adult	OXI-A/N	<3 kg or >40kg (<6.6 lbs or >88 lbs)
<i>OXIMAX</i> Oxiband sensor, reusable, pediatric/infant	OXI-P/I	3 kg to 40 kg (6.6 lbs to 88 lbs)

Table 3: Nellcor Oximetry Sensor Models and Patient Weights (Continued)

<i>OxiMAX</i> Sensor	Model	Patient Size > = greater than < = less than
<i>OxiMAX</i> Dura-Y® multisite sensor, reusable	D-YS	>1 kg (>2.2 lbs)
For use with the Dura-Y sensor:		
Ear clip (Reusable, nonsterile)	D-YSE	>30 kg (66 lbs)
<i>Pedi-Check</i> ™ pediatric spot-check clip (Reusable, nonsterile)	D-YSPD	3 kg to 40 kg (6.6 lbs to 88 lbs)

***OxiMAX* Sensor Features**

OxiMAX sensor features are different for *OxiMAX* sensors by *OxiMAX* sensor type, such as adhesive, recycled, and reusable. The *OxiMAX* sensor type is located on the *OxiMAX* sensor plug.

Table 4: *OxiMAX* Sensor Features

Feature	Adhesive Sensors	Recycled Sensors	Reusable Sensors
<i>OxiMAX</i> Sensor Event Record	Yes	No	No
Sensor Messages	Yes	Yes	Yes
Sensor ID Message	Yes	Yes	Yes

Biocompatibility Test

Biocompatibility testing has been conducted on Nellcor *OxiMAX* sensors in compliance with ISO 10993-1, Biological Evaluation of Medical Devices, Part 1: Evaluation and Testing. The *OxiMAX* sensors have passed the recommended biocompatibility testing and are, therefore, in compliance with ISO 10993-1.

Optional Accessories

The optional accessories offered with the monitor are:

- rubber boot with clip, page 78
- functional thermoformed holster, page 79
- carrying case, page 80
- water-resistant jacket, page 81
- printer, page 82
- thermal paper, page 83
- DEC-4 extension cable, page 84
- transport boot, page 85

Rubber Boot With Clip

This accessory protects the monitor.

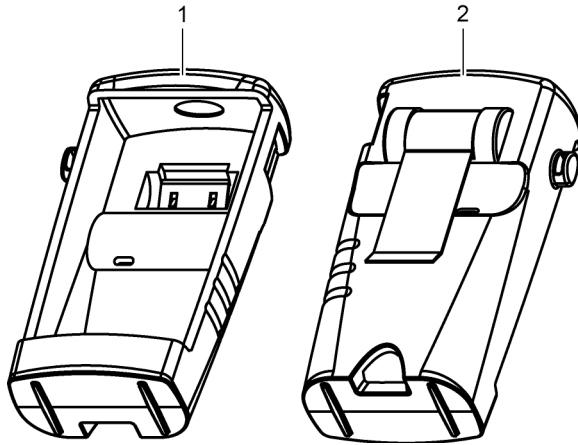

1 — Front view | 2 — Rear view

Figure 4: Rubber Boot with Clip

Functional Thermoformed Holster

This accessory protects the monitor.

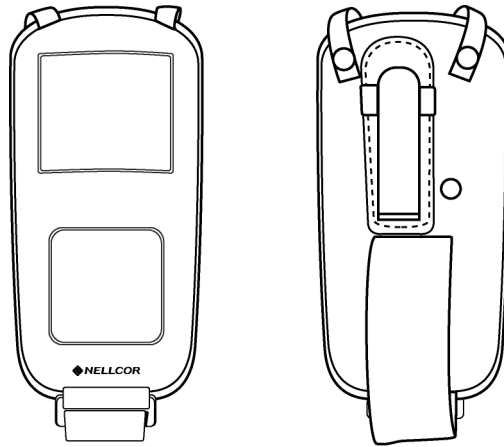

1 — Front view | 2 — Rear view

Figure 5: Functional Thermoformed Holster

Carrying Case

The Nylon carrying case is equipped with compartments for:

- the monitor
- Operator's manual
- compact disk containing all manuals
- sensors

and,

- a carrying strap that is adjustable from 71 cm to 135 cm (28 inches to 53 inches)

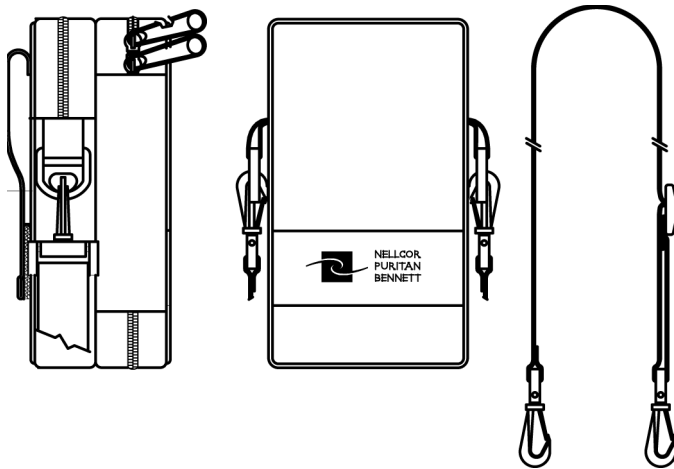

Figure 6: Carrying Case

Water-Resistant Jacket

The water-resistant jacket is made of clear plastic to facilitate use of the monitor in inclement weather or similar conditions.

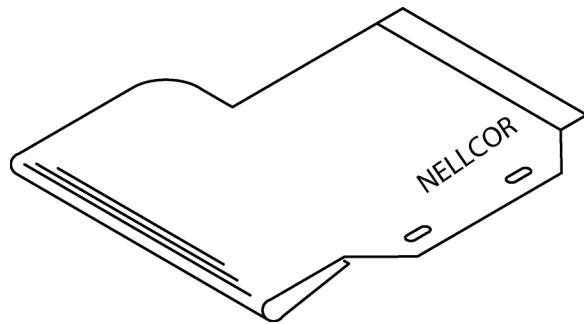

Figure 7: Water-Resistant Jacket

Infrared Printer

The Citizen PD-22T portable printer is used to print selected data from the monitor. The monitor uses the printer IrDA infrared interface. Refer to the User's Manual supplied with the printer for details on the PD-22T printer.

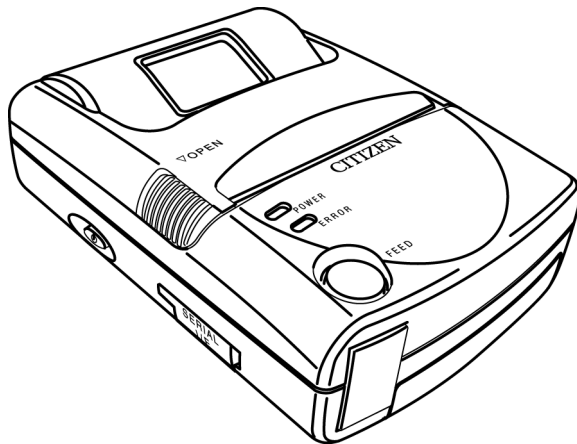

Figure 8: Printer

Thermal Paper

The thermal paper is for the Citizen PD-22T infrared printer. Refer to the User's Manual supplied with the printer for details on the thermal paper.

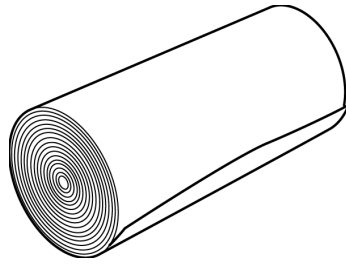
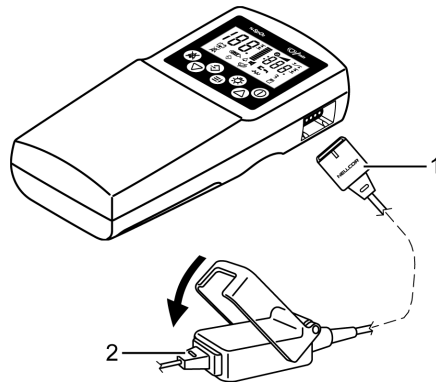

Figure 9: Thermal Paper

DEC-4 Extension Cable

The DEC-4 extension cable provides 1.2 m (4 ft.) of cable extension between the monitor and the sensor.



1 — DEC-4 extension cable

2 — Sensor connector

Figure 10: DEC-4 Extension Cable

Transport Boot

This accessory is used in the transport environment for compliance with ISO 9919 outside of a hospital, such as ambulance transport.

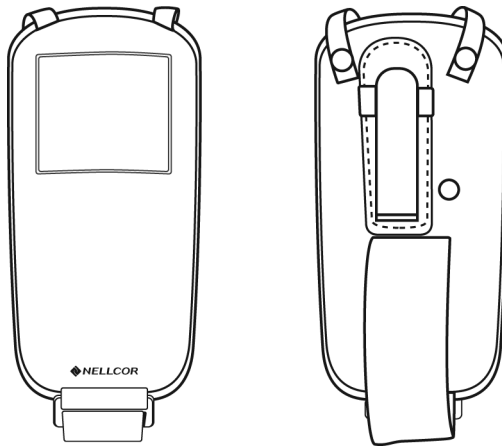

1 — Front view | 2 — Rear view

Figure 11: Transport Boot

Performance Considerations



WARNING: Pulse oximetry readings and pulse signals can be affected by ambient environmental conditions, *OXIMAX* sensor application errors, and patient conditions. See the appropriate sections of the manual for specific safety information, such as *Safety Information on page 1* and *OXIMAX Sensors and Accessories on page 71*.

Performance Verification

The performance of the *OXIMAX* N-65 is verified by following the procedures outlined in the Performance Verification section of the monitor service manual. Qualified service personnel should perform these procedures before using the monitor for the first time in a clinical setting.

OXIMAX N-65 Performance Considerations

This section describes patient conditions that can affect the monitor's measurements.

Dysfunctional Hemoglobins

Dysfunctional hemoglobins, such as, carboxyhemoglobin, methemoglobin, and sulfhemoglobin, are unable to carry oxygen. SpO₂ readings may appear normal; however, a patient may be hypoxic because less hemoglobin is available to carry oxygen. Further assessment beyond pulse oximetry is recommended.

Anemia

Anemia causes decreased arterial oxygen content. Although SpO₂ readings may appear normal, an anemic patient may be hypoxic. Correcting anemia can improve arterial oxygen content. The monitor may fail to provide an SpO₂ if hemoglobin levels fall below 5 gm/dl.

Saturation

The monitor displays saturation levels between 1% and 100%.

Pulse Rates

The monitor displays pulse rates between 20 and 300 beats per minute. The sensor accuracy ranges do not apply to pulse rates above 250 bpm. Detected pulse rates below 20 are shown as 0.

OxIMAX Sensor Performance Considerations



WARNING: Pulse oximetry readings and pulse signal can be affected by ambient conditions, *OxIMAX* sensor application errors, and patient conditions.



WARNING: Tissue damage can be caused by incorrect application or inappropriate duration of use of an SpO₂ *OxIMAX* sensor. Inspect the *OxIMAX* sensor site as directed in the *OxIMAX* sensor directions for use.



WARNING: Use only Nellcor-approved *OxIMAX* sensors and extension cables. Do not use cables more than 4 feet in length. Use only the DEC-4 extension cable or only the *OxIMAX* sensor.

Inaccurate measurements can be caused by:

- incorrect application of the *OxIMAX* sensor
- placement of the *OxIMAX* sensor on an extremity with a blood pressure cuff, arterial catheter, or intravascular line
- excessive patient activity
- intravascular dyes, such as indocyanine green or methylene blue
- externally applied coloring, such as nail polish or pigmented cream
- failure to cover the *OxIMAX* sensor site with opaque material in high ambient light conditions
- venous pulsation
- dysfunctional hemoglobin

- low perfusion

Loss-of-pulse signal can occur for the following reasons:

- the *OxiMAX* sensor is applied too tightly
- defibrillation
- a blood pressure cuff is inflated on the same extremity as the one with the *OxiMAX* sensor attached
- there is arterial occlusion proximal to the *OxiMAX* sensor
- poor peripheral perfusion
- loss of pulse/cardiac arrest

To use the *OxiMAX* sensor:

- Select an appropriate *OxiMAX* sensor.
- Apply the sensor as directed, and observe all warnings and cautions presented in the Directions For Use accompanying the *OxiMAX* sensor.
- Clean and remove any substances, such as nail polish, from the application site.
- Periodically check to ensure that the *OxiMAX* sensor remains properly positioned on the patient.

High ambient light sources that can interfere with the performance of an SpO₂ *OxiMAX* sensor are:

- surgical lights (especially those with a xenon light source)
- bilirubin lamps
- fluorescent lights
- infrared heating lamps
- direct sunlight

To prevent interference from ambient light, ensure that the *OxiMAX* sensor is properly applied, and cover the *OxiMAX* sensor site with opaque material.

If interference due to patient activity presents a problem, try one or more of the following to correct the problem:

- verify that the *OxiMAX* sensor is properly and securely applied
- move the *OxiMAX* sensor to another site
- use an adhesive *OxiMAX* sensor
- use a new *OxiMAX* sensor with fresh adhesive backing
- keep the patient still, if possible

If interference due to poor perfusion presents a problem, consider using the MAX-R *OxiMAX* sensor or the MAX-FAST *OxiMAX* sensor. The MAX-R *OxiMAX* sensor obtains measurements from the nasal septal anterior ethmoid artery, an artery supplied by the internal carotid. These *OxiMAX* sensors may obtain measurements when peripheral perfusion is relatively poor.

Troubleshooting



WARNING: If you are uncertain about the accuracy of any measurement, check the patient's vital signs by alternate means; then make sure the *OxIMAX* N-65 is functioning correctly.



WARNING: There are no user-serviceable parts inside the *OxIMAX* N-65. The cover should only be removed by qualified service personnel.



Caution: Do not spray, pour, or spill any liquid on the *OxIMAX* N-65, its accessories, connectors, switches, or openings in the enclosure as this may damage the monitor.

Error Codes

When the monitor detects an error condition, it may display “Er” followed by the error code.

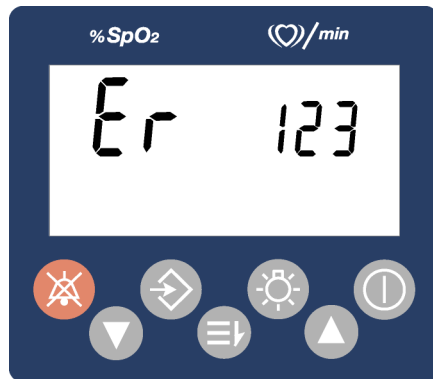

See Table 5, "Error Codes", on page 94 for a list of error codes and corrective actions.

When an error occurs, the unit:

- stops monitoring
- removes all information from the display and displays the message "Er XXX"
- sounds a low priority alarm

When an error occurs, you must:

- Turn the monitor off.
- Wait 10 seconds and turn the monitor on.
- If the error appears, follow the action(s) listed in Table 5.

Table 5: Error Codes

Error Code	Action
10	Check/replace sensor/extension cable.
11	1 — Replace batteries. 2 — Notify service personnel.
17	Check/replace sensor/extension cable.
19	Check/replace sensor/extension cable.
273	1 — Restart the monitor. 2 — Set the time and date. 3 — Notify service personnel.
274	Return the monitor for reprogramming.
275	Check/replace sensor/extension cable.
276	Replace with OXIMAX sensor.

Table 5: Error Codes (Continued)

Error Code	Action
277	Check/replace sensor/extension cable.
280	Check/replace sensor/extension cable.
282	Check/replace sensor/extension cable.
521	Replace batteries.
522	Replace batteries.
523	1 — Restart the monitor. 2 — Set the time and date. 3 — Notify service personnel.
525	1 — Restart the monitor. 2 — Notify service personnel.
538	Set time and date.
539	1 — Restart the monitor. 2 — Notify service personnel.
543	Set the monitor time and date.

Corrective Action

If you experience a problem while using the monitor and are unable to correct it, contact qualified service personnel or your local Nellcor representative. The *OxiMAX* N-65 service manual, which is for use by qualified service personnel, provides additional troubleshooting information.

The current copy of the service manual is available on the Internet at:

http://www.mallinckrodt.com/respiratory/resp/Serv_Supp/ProductManuals.html

Following is a list of possible errors and suggestions for correcting them.

1. There is no response to the Power button.

- Ensure that the **Power** button is fully depressed.
- The batteries may be missing, discharged, or oriented incorrectly. Install new batteries. See *Battery Installation* on page 33.

2. One or more display segments or indicators do not light during the power-on-self-test.

- Do not use the monitor; contact qualified service personnel or your local Nellcor Representative.

3. The Pulse Search indicator displays for more than 10 seconds.

- Check the sensor directions for use to determine if an appropriate sensor is being used and if it is applied properly. Check sensor and extension cable connections. Test the sensor on another subject. Try another sensor or extension cable.
- Perfusion may be too low for the monitor to track the pulse. Check the patient. Test the monitor on yourself. Change the sensor site. Try another sensor.
- Interference due to patient activity may be preventing the monitor from tracking the pulse. Keep the patient still, if possible. Verify that the sensor is securely applied and replace it, if necessary. Change the sensor site.
- The sensor may be too tight, there may be interference due to ambient light, or the sensor may be on an extremity with a blood pressure cuff, arterial catheter, or intravascular line. Reposition sensor, as necessary.
- Electromagnetic interference may be preventing the monitor from tracking the pulse. Remove the source of interference.

4. The Pulse Search indicator lights after successful measurements have been made.

- Check the patient.
- Perfusion may be too low for the monitor to track the pulse. Test the monitor on another subject. Change the sensor site. Try another type of sensor.
- Interference due to patient activity may be preventing the monitor from tracking the pulse. Keep the patient still, if possible. Verify that the sensor is securely applied and replace it if necessary. Change the sensor site.
- The sensor may be too tight, there may be interference due to ambient light, or the sensor may be on an extremity with a blood pressure cuff, arterial catheter, or intravascular line. Reposition sensor, as necessary.
- Electromagnetic interference may be preventing the monitor from tracking the pulse. Remove the source of interference.

5. “Er” followed by a number appears on the display.

- Disconnect the sensor from the monitor. Restart the monitor. If error code appears again, record the number and provide that information to qualified service personnel or your local Nellcor representative.

EMI (Electromagnetic Interference)



Caution: This device has been tested and found to comply with the limits for medical devices to the EN60601-1-2, (second edition), and the Medical Device Directive 93/42/EEC. These limits are designed to provide reasonable protection against harmful interference in a typical medical installation.

Due to the proliferation of radio-frequency transmitting equipment and other sources of electrical noise in health care environments, it is possible that high levels of such interference due to close proximity, or strength of a source, may result in disruption of performance of this device. Examples of noise sources in healthcare environments that could cause electromagnetic interference are:

- electrosurgical units
- cellular phones
- mobile two-way radios
- electrical appliances
- high-definition television

The monitor is designed for use in environments in which the pulse can be obscured by electromagnetic interference. During such interference, measurements may seem inappropriate or the monitor may not seem to operate correctly.

Disruption may be evidenced by erratic readings, cessation of operation, or other incorrect functioning. If this occurs, the site of use should be surveyed to determine the source of this disruption, and the following actions taken to eliminate the source:

- Turn equipment in the vicinity off and on to isolate the offending equipment.
- Reorient or relocate the interfering equipment.
- Increase the separation between the interfering equipment and this equipment.

The monitor generates, uses, and can radiate radio frequency energy. If it is not installed and used in accordance with these instructions, the monitor may cause harmful interference with other devices in the vicinity.

Technical Assistance

For technical information and assistance, or to order parts or a service manual, contact Nellcor's Technical Service Department at:

1.800.635.5267

Or call your local Nellcor representative. The service manual includes block diagrams and a parts list required by qualified personnel when servicing the *OxiMAX* N-65.

Be sure to provide the software version number of the monitor when you request technical assistance.

The software version appears in the monitor display each time the it successfully completes the power-on self-test. Write the number down so it is available when you request technical assistance.

This manual and the *OxiMAX* N-65 Service Manual are available on the Internet at:

http://www.mallinckrodt.com/respiratory/resp/Serv_Supp/ProductManuals.html

Maintenance



WARNING: There are no user-serviceable parts inside the *OxIMAX* N-65. The cover should only be removed by qualified service personnel.



Caution: The institution should follow local government regulations and recycling instructions regarding disposal or recycling of the batteries and *OxIMAX* N-65 components or end of life of the monitor.



Caution: The *OxIMAX* N-65 will not operate with dead batteries. Install new batteries.

Return the *OxIMAX* N-65

Contact Nellcor's Technical Service Department at:

1.800.635.5267

for shipping instructions including a Returned Goods Authorization (RGA) number.

Unless otherwise instructed by Nellcor's Technical Service Department, it is not necessary to return the *OxIMAX* sensor or other accessory items with the *OxIMAX* N-65.

To return the *OXIMAX* N-65:

1. Pack the monitor in its original shipping carton. If the original carton is not available, use a suitable carton with appropriate packing material to protect it during shipping.
2. Return the monitor by any shipping method that provides proof of delivery.

Service



WARNING: There are no user-serviceable parts inside the *OXIMAX* N-65. Only qualified service personnel should remove the cover.

The monitor requires no calibration.

If service is necessary, contact qualified service personnel or your local Nellcor Representative.

Periodic Safety Checks

It is recommended that the following checks be performed every 24 months:

- inspect the equipment for mechanical and functional damage
- inspect the safety relevant labels for legibility

Cleaning



Caution: Do not spray, pour, or spill any liquid on the *OxIMAX* N-65 its accessories, connectors, switches, or openings in the enclosure as this may damage the monitor.

You can surface-clean and disinfect the monitor and the *OxIMAX* sensor.

To surface-clean the monitor:

- use a soft cloth dampened with either a commercial, nonabrasive cleaner, or a solution of 70% alcohol in water
- lightly wipe the surfaces of the monitor

To disinfect the monitor:

- use a soft cloth saturated with a solution of 10% chlorine bleach in tap water

To clean and disinfect an SpO₂ *OxIMAX* reusable sensor:

- read the directions for use enclosed with the *OxIMAX* sensor

Each *OxIMAX* sensor model has cleaning and disinfecting instructions specific to that *OxIMAX* sensors.

Menu Structure

Set Menus Quick Reference

This section contains quick reference information on how to set monitor parameters and limits using the menu structure.

See *Set Menu Parameters* on page 108 to set the following parameters:

- high and low SpO₂ limits
- high and low BPM limits
- alarm volume
- pulse beep volume
- data printing

See *Set Time/Date Parameters* on page 110 to set the following parameters:

- Hour
- Minute
- Day
- Month
- Year

Set Menu Parameters

To set menu parameters, press the **Menu** button repeatedly during normal operation to display the parameters to set. Use the **Up Arrow** button or **Down Arrow** button to adjust the parameter limit. Press the **Menu** button to return to the default monitoring display.

Table 6: Menu Structure

















# of Presses	Parameter	Press	Function
1 	% SpO ₂ Low Limit	 	Adjust limit
2 	% SpO ₂ High Limit	 	Adjust limit
3 	BPM Low Limit	 	Adjust limit
4 	BPM High Limit	 	Adjust limit

Table 6: Menu Structure (Continued)

# of Presses	Parameter	Press	Function
5	Pulse Beep Volume	 	Adjust volume. Indications on blip bar.
6	Alarm Volume	 	Adjust volume. Indications on blip bar.
7	Print Data		Print summary and/or stored snap-shot and sensor-event data.

Set Time/Date Parameters

To access the Time/Date settings menu, press the **Menu** button during start-up Power-On-Self-Test (POST). Press the **Menu** button repeatedly to display the time/date parameters to set. Use the **Up Arrow** button and **Down Arrow** button to adjust time/date settings. Press the **Menu** button to return to the POST display.











When the month entry is made, the monitor checks the day selection to see if it is valid. If the day selection is not valid for the month selected the menu display returns to the day selection display.

When the year entry is made, the monitor checks the day and month selections to see if they are valid. If the day or month selection is not valid for the year selected the menu display returns to the day selection display.

Examples of invalid dates are:

- 30 February
- 31 February
- 31 April
- 31 June
- 31 September
- 31 November
- 29 February on a non-leap year

Table 7: Time Set Menu

# of Presses	Parameter	Press	Function
 <p>The Menu button must be pressed during the POST.</p>			
1	Hour	 	Adjust 1 to 23
2	Minute	 	Adjust 1 to 59
3	Day	 	Adjust 1 to 31
4	Month	 	Adjust 1 to 12
5	Year	 	Adjust 2003 to 2099

Principles of Operation

Oximetry Overview

The *OxiMAX* N-65 uses pulse oximetry to measure functional oxygen saturation in the blood. Pulse oximetry works by applying an *OxiMAX* sensor to a pulsating arteriolar vascular bed, such as a finger or toe. The *OxiMAX* sensor contains a dual light source and a photo detector.

Bone, tissue, pigmentation, and venous vessels normally absorb a constant amount of light over time. The arteriolar bed normally pulsates and absorbs variable amounts of light during the pulsations. The ratio of light absorbed is translated into a measurement of functional oxygen saturation (SpO₂). Because a measurement of SpO₂ is dependent upon light from the *OxiMAX* sensor, excessive ambient light can interfere with this measurement.

For additional information about ambient conditions, *OxiMAX* sensor application, and patient conditions, see *OxiMAX N-65 Performance Considerations* on page 87.

Pulse oximetry is based on two principles:

- oxyhemoglobin and deoxyhemoglobin differ in their absorption of red and infrared light (spectrophotometry)
- the volume of arterial blood in tissue (and hence, light absorption by that blood) changes during the pulse (plethysmography)

A pulse oximeter determines SpO₂ by passing red and infrared light into an arteriolar bed and measuring changes in light absorption during the pulsatile cycle. Red and infrared low-voltage light-emitting diodes (LED) in the oximetry *OxiMAX* sensor serve as light sources; a photo diode serves as the photo detector.

Because oxyhemoglobin and deoxyhemoglobin differ in light absorption, the amount of red and infrared light absorbed by blood is related to hemoglobin oxygen saturation. To identify the oxygen saturation of arterial hemoglobin, the monitor uses the pulsatile nature of arterial flow.

During systole, a new pulse of arterial blood enters the vascular bed, and blood volume and light absorption increase. During diastole, blood volume and light absorption reach their lowest point.

The pulse oximeter bases its SpO₂ measurements on the difference between maximum and minimum absorption (measurements at systole and diastole). By doing so, it focuses on light absorption by pulsatile arterial blood, eliminating the effects of nonpulsatile absorbers such as tissue, bone, and venous blood.

Automatic Calibration

Because light absorption by hemoglobin is wavelength dependent and because the mean wavelength of LEDs varies, an oximeter must know the mean wavelength of the *OxiMAX* sensor's red LED to accurately measure SpO₂.

During monitoring, the monitor's software selects coefficients that are appropriate for the wavelength of that individual *OxiMAX* sensor's red LED; these coefficients are then used to determine SpO₂.

Additionally, to compensate for differences in tissue thickness, the light intensity of the *OxiMAX* sensor's LEDs is adjusted automatically.

Functional versus Fractional Saturation

This pulse oximeter measures functional saturation – oxygenated hemoglobin expressed as a percentage of the hemoglobin that can transport oxygen. It does not detect significant amounts of dysfunctional hemoglobin, such as carboxyhemoglobin or methemoglobin.

In contrast, hemoximeters such as the IL482 report fractional saturation – oxygenated hemoglobin expressed as a percentage of all measured hemoglobin, including measured dysfunctional hemoglobins.

To compare functional saturation measurements to those from an instrument that measures fractional saturation, fractional measurements must be converted as follows:

$$\text{functional saturation} = \frac{\text{fractional saturation}}{100 - (\% \text{carboxyhemoglobin} + \% \text{methemoglobin})} \times 100$$

Measured versus Calculated Saturation

When saturation is calculated from a blood gas partial pressure of oxygen (PO₂), the calculated value may differ from the SpO₂ measurement of a pulse oximeter. This usually occurs because the calculated saturation was not appropriately corrected for the effects of variables that shift the relationship between PO₂ and pH, temperature, the partial pressure of carbon dioxide (PCO₂), 2,3-DPG, and fetal hemoglobin. See Figure 12 on page 116.

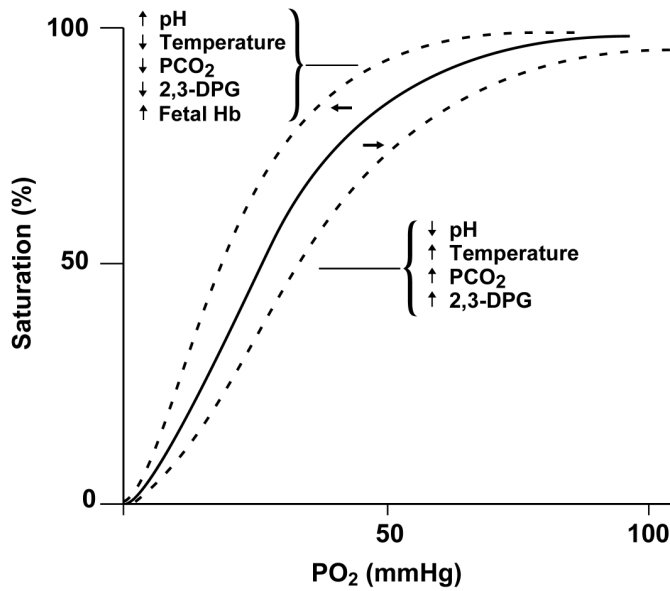

Figure 12: Oxyhemoglobin Dissociation Curve

OxIMAX Technology

The *OxIMAX* N-65 is designed to use Nellcor *OxIMAX* brand sensors, which integrate the *OxIMAX* technology. These *OxIMAX* sensors are identified by their deep lavender/blue plug color. All *OxIMAX* sensors contain a memory chip carrying information about the *OxIMAX* sensor, which the oximeter needs for correct operation, including the *OxIMAX* sensor's calibration data, model type, troubleshooting codes, and error detection data.

When an *OxIMAX* sensor is connected to the monitor, the pulse oximeter first reads the information in the *OxIMAX* sensor memory chip, checks it to make sure that there are no errors, and then loads the data to begin monitoring. This process takes a few seconds.

Pulse oximeters containing *OxiMAX* technology, including the *OxiMAX* N-65, use calibration data contained in the *OxiMAX* sensor in calculating the patient's SpO₂. Consult the *OxiMAX* sensor accuracy grid card included with the pulse oximeter for specific accuracy information for the *OxiMAX* N-65 with different Nellcor *OxiMAX* sensors.

Functional Testers and Patient Simulators

Some models of commercially available bench top functional testers and patient simulators can be used to verify the proper functionality of Nellcor pulse oximeter sensors, cables, and monitors. See the individual testing device's operator's manual for the procedures specific to the model of tester being used.

While such devices may be useful for verifying that the pulse oximeter sensor, cabling, and monitor are performing as designed, they are incapable of providing the data required to properly evaluate the accuracy of SpO₂ measurements. Fully evaluating the accuracy of the SpO₂ measurements requires, at minimum, accommodating the wavelength characteristics of the sensor and reproducing the complex optical interaction of the sensor and the patient's tissue. These capabilities are beyond the scope of known bench top testers. SpO₂ measurement accuracy can only be evaluated in vivo by comparing pulse oximeter readings with values traceable to SaO₂ measurements obtained from simultaneously sampled arterial blood made using a laboratory CO-oximeter.

Many functional testers and patient simulators have been designed to interface with the pulse oximeter's expected calibration curves and may be suitable for use with Nellcor monitors and/or sensors. Not all such devices, however, are adapted for use with the Nellcor *OxiMAX*

digital calibration system. While this will not affect use of the simulator for verifying system functionality, displayed SpO₂ measurement values may differ from the setting of the test device. For a properly functioning monitor, this difference will be reproducible over time and from monitor to monitor within the performance specifications of the test device.

Specifications

Performance

Measurement Range

SpO ₂	1% to 100%
Pulse Rate	20 beats per minute (bpm) to 250 bpm
Perfusion Range	0.03% to 20%

Accuracy Tolerance

Saturation

Adult ¹	70 to 100% ±2 digits
Neonate	70 to 100% ±3 digits
Low Perfusion ²	70 to 100% ±2 digits

Pulse Rate

Adult and Neonate ¹	20 to 250 bpm ±3 digits
Low Perfusion ²	20 to 250 bpm ±3 digits

Accuracy Tolerance (Continued)

¹ Adult specifications are shown for *OxiMax* MAX-A and MAX-N sensors with the N-65. Neonate specifications are shown for *OxiMax* MAX-N sensors with the N-65. Saturation accuracy will vary by sensor type. Refer to the Sensor Accuracy Grid. The Sensor Accuracy Grid is shipped with the N-65. The latest version of the Sensor Accuracy Grid is available on the Internet at:

http://www.mallinckrodt.com/respiratory/resp/Serv_Supp/ProductManuals.html

² Reading accuracy in the presence of low perfusion (detected IR pulse modulation amplitude <1.5%) was validated using signals supplied by a patient simulator. SpO₂ and pulse rate values were varied across the monitoring range over a range of weak signal conditions and compared to the known true saturation and pulse rate of the input signals.

Display Update Interval

100 millisecond

Audible Indicators

Audible Indicator	Parameter	Value
Alarm Volume Setting	Volume level	Adjustable, 40 to 52 dB(A), at one meter
	Pitch (± 30 Hz)	752 Hz
	On pulse width (± 20 msec)	500 msec
	Off Interval (± 20 msec)	10 msec
	Number of pulses in burst	1
	Repetition Pause (± 2 sec.)	N/A
	Priority	1
Beep Volume setting	Volume level	Adjustable, 42 to 52 dB(A), at one meter
	Pitch (± 30 Hz)	1500 Hz
	On pulse width (± 20 msec)	500 msec
	Off Interval (± 20 msec)	10 msec
	Number of pulses in burst	1
	Repetition Pause (± 2 sec.)	N/A
	Priority	2

Audible Indicators (Continued)

Audible Indicator	Parameter	Value
POST Pass	Volume level	Fixed at 45 dB(A), at one meter
	Pitch (± 30 Hz)	600 Hz
	On pulse width (± 20 msec)	1000 msec
	Off Interval (± 20 msec)	10 msec
	Number of pulses in burst	1
	Repetition Pause (± 2 sec.)	N/A
	Priority	3
Invalid Key Press	Volume level	Fixed at 45 dB(A), at one meter
	Pitch (± 30 Hz)	200 Hz
	On pulse width (± 20 msec)	50 msec
	Off Interval (± 20 msec)	10 msec
	Number of pulses in burst	1
	Repetition Pause (± 2 sec.)	N/A
	Priority	4

Audible Indicators (Continued)

Audible Indicator	Parameter	Value
Confirmation	Volume level	Fixed at 45 dB(A), at one meter
	Pitch (± 30 Hz)	700 Hz
	On pulse width (± 20 msec)	130 msec
	Off Interval (± 20 msec)	130 msec
	Number of pulses in burst	3
	Repetition Pause (± 2 sec.)	N/A
	Priority	5
Valid Key Press	Volume level	Fixed at 45 dB(A), at one meter
	Pitch (± 30 Hz)	800 Hz
	On pulse width (± 20 msec)	10 msec
	Off Interval (± 20 msec)	10 msec
	Number of pulses in burst	1
	Repetition Pause (± 2 sec.)	N/A
	Priority	6

Audible Indicators (Continued)

Audible Indicator	Parameter	Value
Pulse Beep	Volume level	Adjustable, 42 to 52 dB(A), at one meter
	Pitch (± 30 Hz)	1500 Hz
	On pulse width (± 20 msec)	50 msec
	Off Interval (± 20 msec)	10 msec
	Number of pulses in burst	1
	Repetition Pause (± 2 sec.)	N/A
	Priority	7
Alarm Silence Reminder	Volume level	Adjustable, 42 to 52 dB(A), at one meter
	Pitch (± 30 Hz)	500 Hz
	On pulse width (± 20 msec)	130 msec
	Off Interval (± 20 msec)	130 msec
	Number of pulses in burst	3
	Repetition Pause (± 2 sec.)	179.27 sec.
	Priority	8

Audible Indicators (Continued)

Audible Indicator	Parameter	Value
High Priority Alarm	Volume level	Adjustable, 42 to 52 dB(A), at one meter
	Pitch (± 30 Hz)	1200 Hz
	On pulse width (± 20 msec)	250 msec
	Off Interval (± 20 msec)	80 msec
	Number of pulses in burst	1
	Repetition Pause (± 2 sec.)	0 sec.
	Priority	9
Medium Priority Alarm	Volume level	Adjustable, 42 to 52 dB(A), at one meter
	Pitch (± 30 Hz)	752 Hz
	On pulse width (± 20 msec)	400 msec
	Off Interval (± 20 msec)	300 msec
	Number of pulses in burst	1
	Repetition Pause (± 2 sec.)	0 sec.
	Priority	10

Audible Indicators (Continued)

Audible Indicator	Parameter	Value
Low priority Alarm	Volume level	Adjustable, 42 to 52 dB(A), at one meter
	Pitch (± 30 Hz)	500 Hz
	On pulse width (± 20 msec)	400 msec
	Off Interval (± 20 msec)	3200 msec
	Number of pulses in burst	1
	Repetition Pause (± 2 sec.)	0 sec.
	Priority	11

Electrical**Batteries**

Type	Voltage
4 AA alkaline	6 Volts DC (as per 4 AA batteries)

Battery life is typically:

Alkaline 15 hours

Lithium 40 hours

OxiMAX
Sensors

Wavelength	<p>Nellcor pulse oximetry sensors contain LEDs that emit red light at a wavelength of approximately 660 nm and infrared light at a wavelength of approximately 900 nm. The total optical output power of the sensor LEDs is less than 15 mW. This information may be useful to clinicians, such as those performing photodynamic therapy.</p> <p>Note: Sensor LED light emissions fall within Class 1 level, according to IEC 60825-1:2001. No special safety precautions are required.</p>
------------	--

***OxiMAX* Sensor Power Dissipation**

Sensor	Dissipation
<i>OxiMAX</i> MAX-N	52.5 mW
<i>OxiMAX</i> MAX-I	52.5 mW
<i>OxiMAX</i> MAX-P	52.5 mW
<i>OxiMAX</i> MAX-A	52.5 mW
<i>OxiMAX</i> MAX-AL	52.5 mW
<i>OxiMAX</i> MAX-R	52.5 mW
<i>OxiMAX Durasensor</i> DS-100A	52.5 mW
<i>OxiMAX OxiCliq</i> [®] P	52.5 mW
<i>OxiMAX OxiCliq</i> N	52.5 mW
<i>OxiMAX OxiCliq</i> I	52.5 mW
<i>OxiMAX OxiCliq</i> A	52.5 mW
<i>OxiMAX Dura-Y</i> [®] D-YS	52.5 mW
<i>OxiMAX</i> MAX-FAST	52.5 mW

***OXIMAX* Sensor Power Dissipation**

Sensor	Dissipation
<i>OXIMAX</i> Softcare SC-PR	52.5 mW
<i>OXIMAX</i> Softcare SC-NEO	52.5 mW
<i>OXIMAX</i> Softcare SC-A	52.5 mW
<i>OXIMAX</i> Oxiband OXI-A/N	52.5 mW

Environmental Conditions**Operation**

Temperature	5 °C to 40 °C (41 °F to 104 °F)
Altitude	-390 m to 3,012 m (-1,254 ft. to 9,882 ft.)
Atmospheric Pressure	70 kPa to 106 kPa (20.6 in. Hg to 31.3 in. Hg)
Relative Humidity	15% to 95% non-condensing

Transport and Storage (not in shipping container)

Temperature	-20 °C to 60 °C (-4 °F to 140 °F)
Altitude	-390 m to 5,574 m (-1,280 ft. to 18,288 ft.)
Atmospheric Pressure	50 kPa to 106 kPa (14.7 in. Hg to 31.3 in. Hg)
Relative Humidity	15% to 95% non-condensing

Transport and Storage (in shipping container)

Temperature	-20 °C to 70 °C (-4 °F to 158 °F)
Altitude	-390 m to 5,574 m (-1,280 ft. to 18,288 ft.)
Atmospheric Pressure	50 kPa to 106 kPa (14.7 in. Hg to 31.3 in. Hg)

Transport and Storage (in shipping container)

Relative Humidity	15% to 95% non-condensing
-------------------	---------------------------

Physical Characteristics

Weight	0.62 lbs. (0.28 kg)
Dimensions	2.875 in. x 6.25 in. x 1.375 in. (7.3 cm x 15.9 cm x 3.5 cm)

Compliance

Item	Compliant With
Equipment classification	Safety Standards: EN 60601-1: 1990 (A1 + A2), EN 60601-1-2: 2001, UL 60601-1, CAN/CSA C22.2 No. 601.1
Type of protection	Internally powered equipment (on battery power)
Degree of protection	Type BF - Applied part
Mode of operation	Continuous
Front panel and case labeling	IEC 60878, EN 980, ISO 7000, EN 60417-1, EN 60417-2
Button spacing	ISO 7250
Year of manufacture symbol	EN 980
Operation during physical shock	IEC 60068-2-27 at 100 g
Alarm requirements	EN 60601-1-8

Item (Continued)	Compliant With (Continued)
Pulse oximeters	EN 865 and ISO 9919 with Transport Boot (Part number 10007434)
Operation during vibration	IEC 60068-2-6 and IEC 60068-2-34
Radiated and conducted emissions	EN 55011, Group 1, Class B

Manufacturer's Declaration



WARNING: The use of accessories, sensors, and cables other than those specified may result in increased emission and/or create invalid readings of the *OxIMAX* N-65.

The *OxIMAX* N-65 is intended for use in an electromagnetic environment in which radiated RF disturbances are controlled. The customer or user of the monitor can help prevent electromagnetic interference by maintaining a minimum distance between portable and mobile RF communications equipment (transmitters) and the monitor as recommended below, according to the maximum output of the communications equipment.

Table 8: Recommended Separation Distances

Recommended Separation Distances between Portable and Mobile RF Communications Equipment and the *OxiMAX* N-65 (IEC 60601-1-2)

Frequency of Transmitter	150 kHz to 80 MHz	80 MHz to 800 MHz	800 MHz to 2.5 GHz
Equation	$d = \left[\frac{3.5}{V_1} \right] \sqrt{P}$	$d = \left[\frac{3.5}{E_1} \right] \sqrt{P}$	$d = \left[\frac{7}{V_1} \right] \sqrt{P}$
Rated Maximum Output Power of Transmitter in Watts	Separation Distance in Meters	Separation Distance in Meters	Separation Distance in Meters
0.01	0.12	0.12	0.23
0.1	0.38	0.38	0.73
1	1.2	1.2	2.3
10	3.8	3.8	7.3
100	12	12	23

For transmitters rated at a maximum output power not listed above, the separation distance can be estimated using the equation in the corresponding column, where P is the maximum output [power rating of the transmitter in watts (W)] according to the transmitter manufacturer.



Note: At 80 MHz to 800 MHz, the separation distance for the higher frequency range applies.



Note: These guidelines may not apply in all situations. Electromagnetic propagation is affected by absorption and reflection from structures, objects, and people.

Table 9: Cable Compliance**Cables Comply With:**

- RF emissions, EN 55011, Class B/Group 1
- EN 60601-1-2: 2001

Cables and OX/MAX Sensors	Maximum Length
OxiCliq-OC-3 cable	3 ft. (0.9 m)
DEC-4 sensor extension cable	4 ft. (1.2 m)
MAX-FAST sensor	30 in. (76.2 cm)
MAX-A sensor	1.5 ft. (0.5 m)
MAX-AL sensor	3 ft. (0.9 m)
MAX-I sensor	1.5 ft. (0.5 m)
MAX-N sensor	1.5 ft. (0.5 m)
MAX-P sensor	1.5 ft. (0.5 m)
MAX-R sensor	1.5 ft. (0.5 m)
SC-PR sensor	3 ft. (0.9 m)
SC-NEO sensor	3 ft. (0.9 m)
SC-A sensor	3 ft. (0.9 m)
DS-100A sensor	3 ft. (0.9 m)
OXI-A/N sensor	3 ft. (0.9 m)
OXI-P/I sensor	3 ft. (0.9 m)
D-YS sensor	4 ft. (1.2 m)
D-YSE sensor	4 ft. (1.2 m)
D-YSPD sensor	4 ft. (1.2 m)

Table 10: Electronic Emissions

The *OxiMAX* N-65 is intended for use in the electromagnetic environment specified below. The customer or user of the monitor should assure that it is used in such an environment.

Emission Test	Compliance	Electromagnetic Environment - Guidance
RF emissions CISPR 11	Group 1	The <i>OxiMAX</i> N-65 uses RF energy only for its internal function. Therefore, the RF emissions are very low and not likely to cause interference in nearby electronic equipment.
RF emissions CISPR 11	Class B	The <i>OxiMAX</i> N-65 is suitable for use in establishments, including diagnostic establishments and those directly connected to the public low-voltage power supply network that supplies buildings used for domestic purposes.

Table 11: Electromagnetic Immunity

The *OxiMAX* N-65 is intended for use in the electromagnetic environment specified below. The customer or user of the monitor should assure that it is used in such an environment.

Immunity Test	IEC 60601 Test Level	Compliance Level	Electromagnetic Environment Guidance
Electrostatic Discharge (ESD) IEC 61000-4-2	± 6 kV contact ± 8 kV air	Complies	Floors should be wood, concrete, or ceramic tile. If floors are covered with synthetic material, the relative humidity should be at least 30%.
Electrical fast transient/burst IEC 61000-4-4	± 2 kV power supply lines ± 1 kV for input/output lines	Complies	Main power should be that of a typical commercial or hospital environment.
Power Frequency (50/60 Hz) magnetic field	3 A/m	Complies	Power frequency magnetic fields should be at levels characteristic of a typical location in a typical commercial or hospital environment.

Table 12: Electromagnetic Immunity

Immunity Test	IEC 60601 Test Level	Compliance Level	Electromagnetic Environment - Guidance
Conducted RF IEC 61000-4-6	3 Vrms 150 kHz to 80 MHz	3 Vrms	Portable and mobile RF communications equipment should be used no closer to any part of the <i>OxiMAX</i> N-65, including the cables, than the recommended separation distance calculated from the equation applicable to the frequency of the transmitter.
Radiated RF IEC 61000-4-3	3 V/m 80 MHz to 2.5 GHz	3 Vrms	

Recommended Separation Distance

$$d = \left[\frac{3.5}{V_1} \right] \sqrt{P}$$

Where P is the maximum output power rating of the transmitter in watts (W) according to the transmitter manufacturer and d is the recommended separation distance in meters (m).

$$d = \left[\frac{3.5}{E_1} \right] \sqrt{P}$$

80 MHz to 800 MHz

Field strengths from fixed RF transmitters, as determined by an electromagnetic site survey^a, should be less than the compliance level in each frequency range.^b

Table 12: Electromagnetic Immunity

$$d = \left[\frac{7}{V_1} \right] \sqrt{P}$$

800 MHz to
2.5 GHz



Interference may occur in the vicinity of equipment marked with this symbol.



Note 1: At 80 MHz, the higher frequency range applies.



Note 2: These guidelines may not apply in all situations. Electromagnetic propagation is affected by absorption and reflection from structures, objects, and people.

^a Field strength from fixed transmitters, such as base stations for radio (cellular/cordless) telephones and land mobile radios, amateur radio, AM and FM radio broadcast and TV broadcast cannot be predicted theoretically with accuracy. To assess the electromagnetic environment due to fixed RF transmitters, an electromagnetic site survey should be considered. If the measured field strength in which the *OxiMAX* N-65 is used exceeds the applicable RF compliance level above, the monitor should be observed to verify normal operation. If abnormal performance is observed, additional measures may be necessary, such as reorienting or relocating the monitor.

^b Over the frequency range 150 kHz to 80 MHz, field strength should be less than $[V_1]$ V/m.

Index

Symbols

%SpO2 high limit 108

%SpO2 low limit 108

A

accessories 77

accuracy 119

alarm limit changed indicator 61

alarm limit display 56

alarm limits

 setting 56

alarm silence duration 53

alarm silence indicator 22

alarm volume 109

 adjusting 46

anemia 88

audible alarms

 disable 54

audible indicator 24, 121

B

backlight 43

battery

 critical battery indication 32

 installation 33

 low battery indicator 31

battery operation 31

biocompatibility testing 77

bpm high limit 108

bpm low limit 108

C

- calculated saturation 115
- calibration 104
- carrying case 80
- cautions 4
- cleaning 105
- connecting an OXIMAX Sensor 27
- controls 9, 16
 - alarm silence 16
 - backlight 18
 - data (record/print) 17
 - down arrow 17, 18
 - menu 17
 - power 19
 - up arrow 18

D

- dashes 43
- day 111
- DEC-4 extension cable 84
- disable audio alarms 54
- display 9, 19
 - %SpO2 21
- display update interval 120
- dysfunctional hemoglobins 88

E

- electromagnetic interference 99
- error codes 93
- event records 69
- explosion hazard 1
- extension cable
 - DEC-4 84

F

- fractional saturation 115

- front panel
 - buttons 9
 - symbols 9
- functional saturation 115
- functional thermoformed holster 79

H

- hour 111
- how to use this manual 7

I

- indicator
 - alarm silenced 22
 - interference 22
 - low battery 22
 - pulse amplitude 21
- indicators 9, 19
- infrared printer 82
- intended use 7
- introduction 7

L

- label symbols 15
- list of components 27
- low battery indicator 22, 31

M

- manufacturer's declaration 130
- measured saturation 115
- measurements
 - inaccurate 28
- menu
 - set time and date 110
- menu quick reference 107
- menu structure 107
- minute 111
- monitor

- inaccurate measurements 28
- performance considerations 87
- monitor displays dashes 43
- month 111

N

- normal monitoring mode 19
- notes 5

O

- operating
 - altitude 128
 - relative humidity 128
 - temperature 128
- optional accessories 77
- OXIMAX N-65
 - measurement range 119
 - returning 103
- OXIMAX technology 116
- oximetry overview 113

P

- paper 83
- parameter ranges 35
- performance considerations
 - pulse oximeter 87
 - sensor 89
- performance verification 87
- power-on self-test (POST) 36
- print
 - after printing data 65
 - data 63
 - mode 65
- print data 109
- printer 82
- pulse beep volume 109

- adjusting 43
- adjusting during monitoring 44
- adjusting using menu structure 45
- pulse search indicator 23

R

- rear panel symbols 14
- recommended separation distances 131
- record snap-shot data 61
- returning the monitor 103
- rubber boot with clip 78

S

- safety checks 104
- safety information 1
- saturation
 - calculated 115
 - fractional 115
 - functional 115
 - measured 115
- selecting a sensor 73
- sensor
 - features 76
 - performance considerations 89
- sensor event record 70
- sensor models and patient weights 74
- service 104
- set
 - alarm limits 56
 - alarm silence duration 53
 - date 48
 - time 48
- set up the OXIMAX N-65 25
- snap-shot data 61
- specifications 119
 - battery 126

- compliance 129
 - electrical 126
 - environmental 128
 - performance 119
 - physical 129
- storage
 - altitude 128
 - relative humidity 128
 - temperature 128
- symbols 9
 - Canadian ICES-001 approval 15
 - date of manufacture 14
 - decimal points 20
 - European union approval 14
 - fragile 15
 - front panel 13
 - keep away from heat 15
 - keep upright 15
 - label 15
 - protect from moisture 15
 - rear panel 14
 - resistant to liquid ingress 14
 - Russian regulatory approval 15
 - see instructions for use 14
 - serial number 15
 - temperature limitation 15
 - type BF applied part 14

T

- technical assistance 100
- thermal paper 83
- time set menu 111
- transport
 - altitude 128
 - boot 85
 - relative humidity 128

temperature 128
troubleshooting 93
 help 96
turning on the OXIMAX N-65 36

V

verification
 performance 87
volume
 adjusting alarm 46
 pulse beep 43

W

warning 1
water-resistant jacket 81
wavelength, sensor 127

Y

year 111



Tyco Healthcare Group LP
Nellcor Puritan Bennett Division
4280 Hacienda Drive
Pleasanton, CA 94588 U.S.A.
Telephone Toll Free 1.800.635.5267

Authorized Representative
Tyco Healthcare UK LTD
154 Fareham Road
Gosport PO13 0AS, U.K.

© 2006 Nellcor Puritan Bennett Inc.
All rights reserved

Rx ONLY



tyco

Healthcare

10006537B_0106